

naught**one**

contents

Issue 6.0

Environment

Page 4

Information about naughtone's approach to the environment.

Inspire

Pages 6–55

Inspirational images from a broad selection of case studies and more recent product photography.

Products

Pages 56–151

A double page spread per product range to break down the range options in detail.

Further product information including downloadable images and CAD blocks can be found on our website

www.naughtone.com

Please contact naughtone or your furniture dealer directly for any other enquiries.

60	Trace Small Tables	110	Viv 4 Star / 5 Star
62	Fold Steel Leg Tables	112	Viv Highback / Highback Lounge
64	Frog Tables	114	Bounce Chair
66	Dalby Wooden Leg Coffee and Cafe Tables	116	Always Chair
78	Dalby Wooden Leg Tables	118	Always 4 Star / 5 Star
70	Ped Table	120	Always Lounge Chair
72	Megaped Table	122	Fiji Chair / Sofa
74	Ali Table	124	Hush Low Chair
76	Knot Table	126	Hush Low Sofa
78	Riley Table	128	Hush Chair
80	Shard Coatstand	130	Hush Sofa
82	New Hudson Coatstand	132	Cloud Quilt Armchair / Sofa
84	Sideboard Storage	134	Cloud Plain Armchair / Sofa
86	Pollen Stool / Table	136	Cloud Booth Seating
88	Pinch Stool	138	Cloud Desk
90	Lasso Seating	140	Pullman Chair
92	Construct Low Stool / Barstool	142	Pullman Sofa
94	Polly Chair / Barstool	144	Pullman Booth
96	Polly 4 Star / 5 Star	146	Hue Seating
98	Polly Wood Chair / Armchair / Barstool	148	Rhyme Modular Seating
100	New Ruby Wood Chair / Barstool	150	Busby Chair
102	New Ruby Chair / Barstool	152	Portion Chair / Sofa / Bench
104	New Ruby 4 Star / 5 Star	154	Hatch Modular Seating
106	Viv Wood Chair / Lounge / Barstool	156	Symbol Modular Seating
108	Viv Chair / Lounge / Barstool	158	Clyde Club Chair / Sofa / Bench

about us

At naughtone we like to keep things easy; Useful, Beautiful Furniture quite simply explains what we do. Even our name naughtone means no-nonsense.

naughtone is a British company founded in 2005 by industry professionals. We like to consider ourselves friendly experts and we strive to make the process of selecting, purchasing and receiving our products as easy and informative as possible.

Although naughtone is based in Britain our products are available globally. We design and develop in the UK and our manufacturing strategy supports consistent lead times, pricing and environmental factors in our international markets.

We have our own showrooms in the UK and North America and our products can be seen in furniture dealer showrooms all over the world.

naughtone furniture is used by some of the most influential brands in commerce and culture; there is no better proof of the relevance and application of the product range. We have built this useful collection of products by reacting quickly to market demands with as straightforward solution as possible.

In 2019, naughtone was honoured with a prestigious Queen's Award for Enterprise in International Trade, after expanding rapidly to accommodate international growth. The Queen's Awards for Enterprise recognise and celebrate business excellence across the UK.

naughtone was also placed number 1 in The Sunday Times SME Export Track 100 for 2017, named as The Telegraph's Fastest Growing British Export SME 2018, placed number 22 in The Sunday Times Lloyds SME Export Track 100 for 2018 and placed number 81 in the Sunday Times Virgin Atlantic Fast Track 100 for 2018.

To view our full range of products visit www.naughtone.com



Environment

naughtone has always considered the environment throughout our design and manufacturing process. We understand that as we continue to grow, so does our potential impact on our surroundings. As most of our raw materials are simple, we have great control over their sources, and are proud to be able to offer FSC® certified upholstered products and use recycled metals in our table ranges.

The addition of our North American manufacturing provision also helps to keep manufacturing miles to a minimum, as our market continues to grow in the USA. Finally, naughtone offers a 'bring back' programme, where the client is able to return the product to our factory, where we will be happy to breakdown and recycle the parts for you.

For more information please contact your sales representative or visit

www.naughtone.com/green-credentials

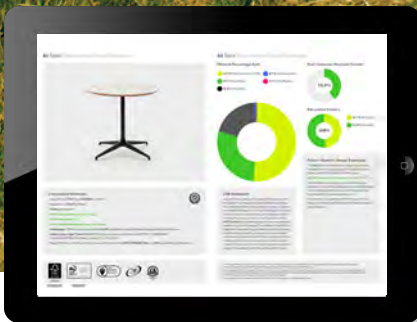

We have a comprehensive range of downloadable product brochures for every naughtone product. These have been designed to document all the relevant product information in one easy to use extended product brochure. These cover all frequently asked questions and are handy when specifying a project.

Every product range now has a dedicated extended brochure that is available for download from the product pages on the website and through the resources area.



1 Design

Every aspect of the naughtone product ranges has been designed with the environment considered, from ethical material choice and production efficacy to storage efficiency and ease of disassembly.

Dense foam sets and resilient fabrics are selected for their longevity and effectiveness across sectors. Durable high quality finishes such as powder coated bases in a range of colours allow clients the freedom of finish options. Finish samples are available allowing clients to make informed decisions and retain to add to their finish libraries for future reference.

2 Raw Material

Local supply of raw materials is employed for the production of our products when possible, procured from suppliers that are quality inspected for extraction methods and meet the highest environmental standards.

3 Production

As many of our products are assembled by hand the energy expenditure wasted from machinery during the production process is kept to a minimum.

All fabrics are cut to ensure optimum efficiency with fabric usage and reduced waste consumption per unit.

All production sites have recycling facilities for any excess product that cannot be used elsewhere, which is then managed by a professional third party.

4 Distribution

Distribution of naughtone products generally occurs directly between the manufacturing site to the client. Production is localised when possible to the US or UK regions, reducing the carbon footprint and miles travelled for each product.

Many items are flat packed for delivery or shipped disassembled with efficient, minimised packaging; optimizing the transportation vessel space.

5 Usage

naughtone products do not require energy or water to function, thus no environmental exchange takes place and no waste is generated during the life of the product.

The only foreseeable need is the cleaning of the product for general maintenance. This includes regular vacuuming to remove dirt and dust particles on upholstery items, and using a dry or damp cloth to wipe non-upholstery items.

This is recommended for all products utilised under conditions of normal wear and is expected to have negligible environmental impacts.

6 End of Life

Although our products are durable and demonstrate timeless design, naughtone products are manufactured in such a way that they can be easily disassembled at the end of life and most of the componentry can be either recycled or re-used as applicable.

As a company we are also happy to accept the return of products, to help re-home or recycle furniture or components at the end of the products useful life.



FSC® certified products available upon request



naughtone offers PEFC certified products



inspire

Inspirational images from a broad selection of case studies and recent product photography

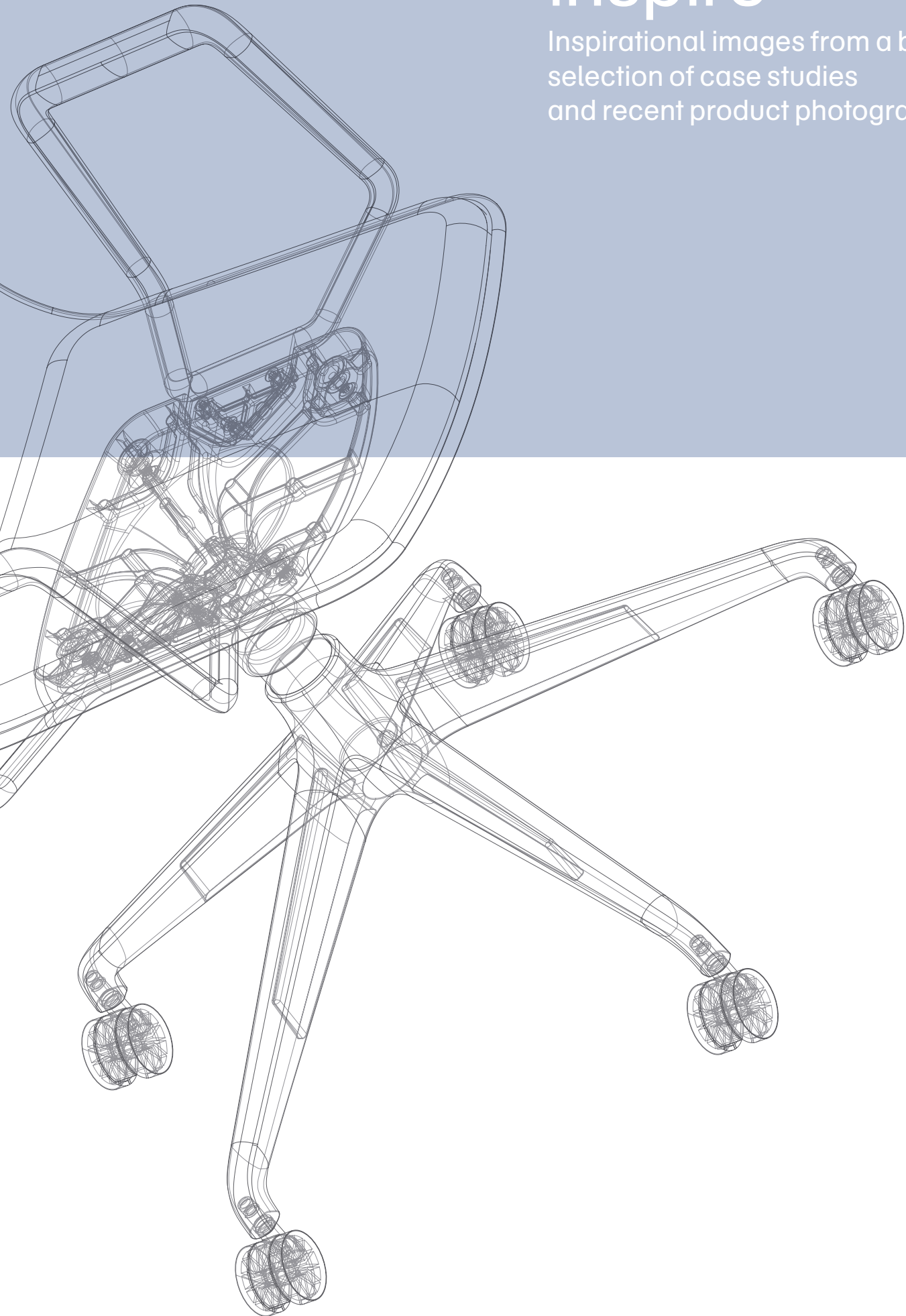



Cambridge Judge
Business School
Cambridge, UK



meeting

Croxley Park

Watford, UK

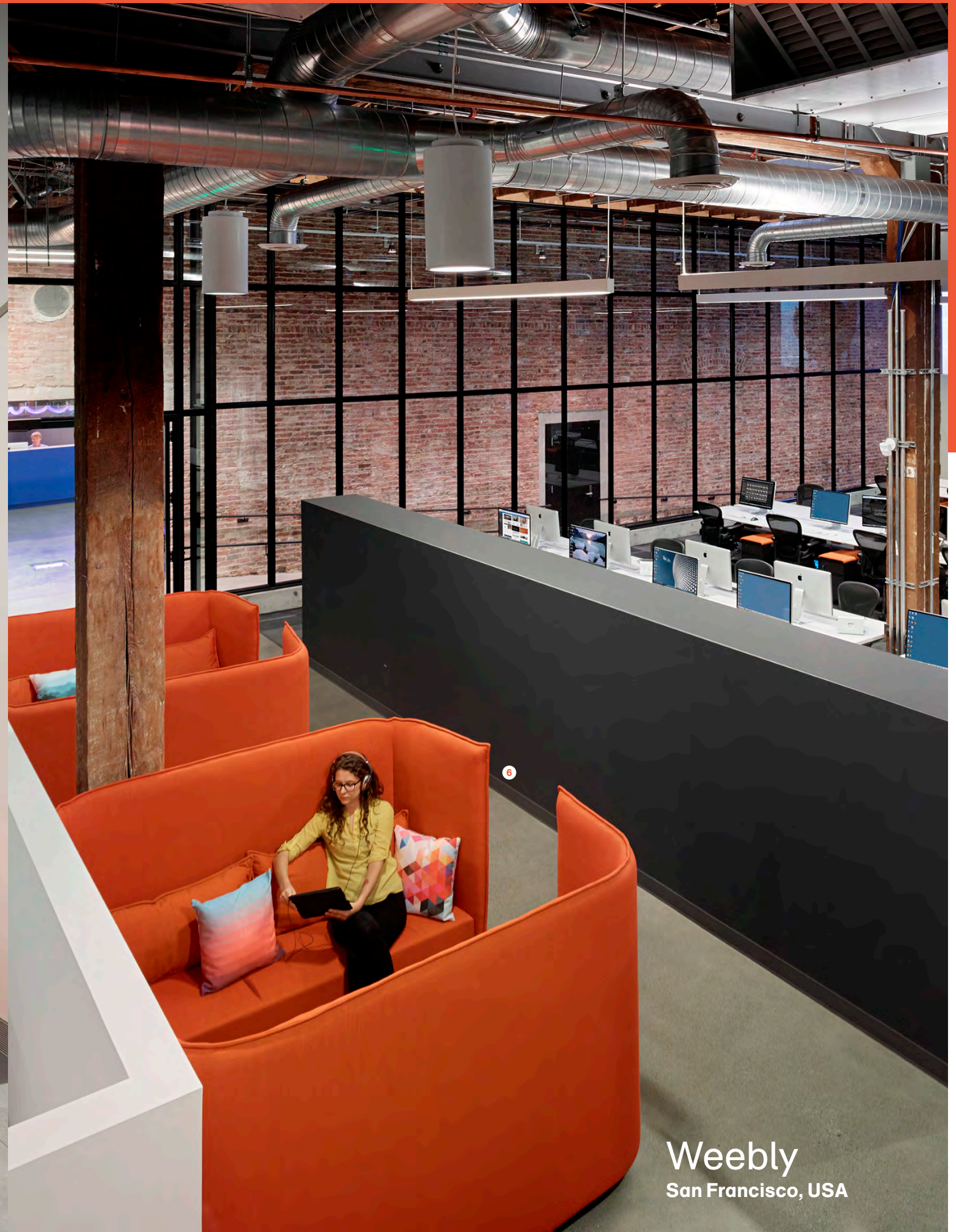
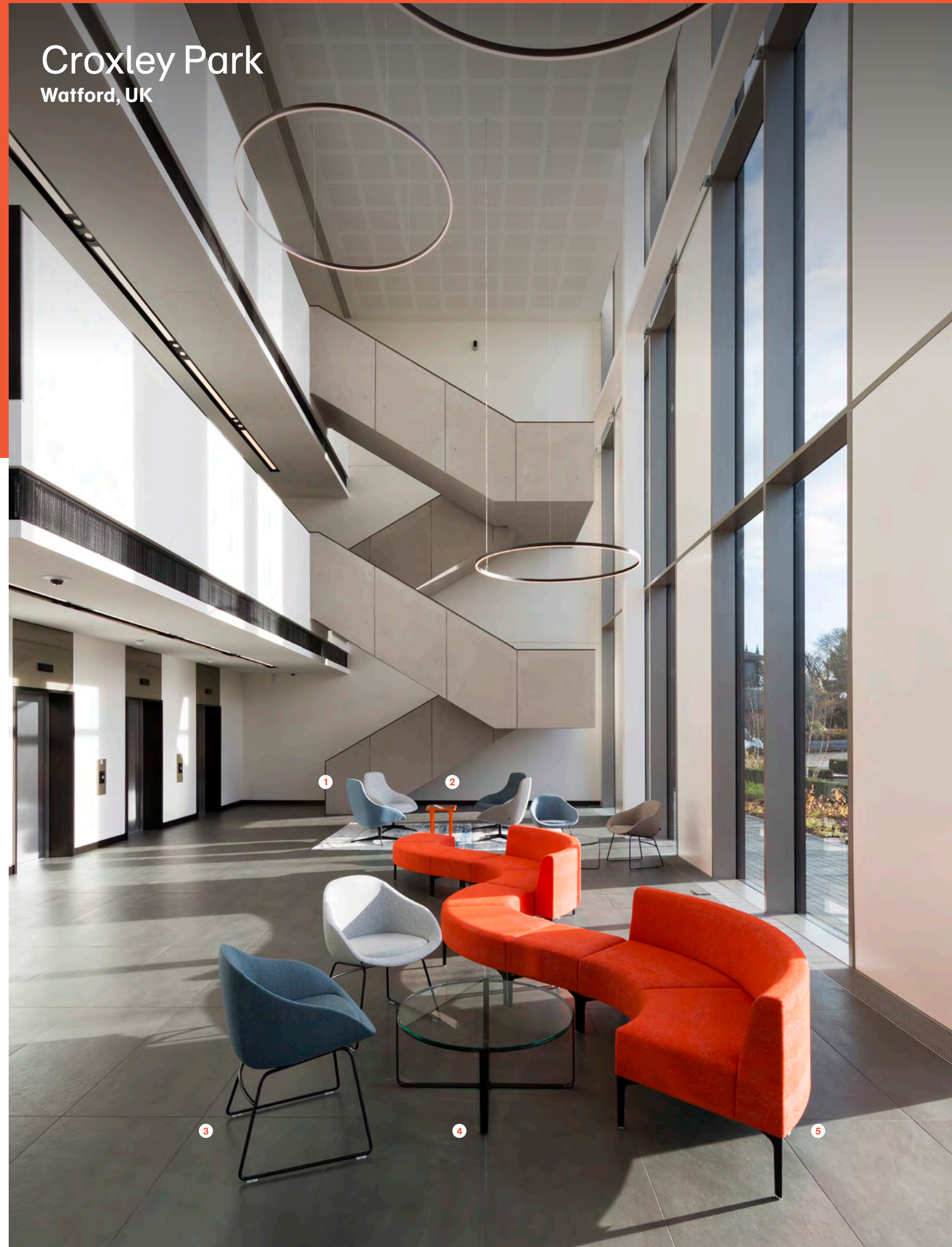

Weebly

San Francisco, USA



break out

Technology Company

Minnesota, USA





break out



MSV Housing Association
Manchester, UK



working

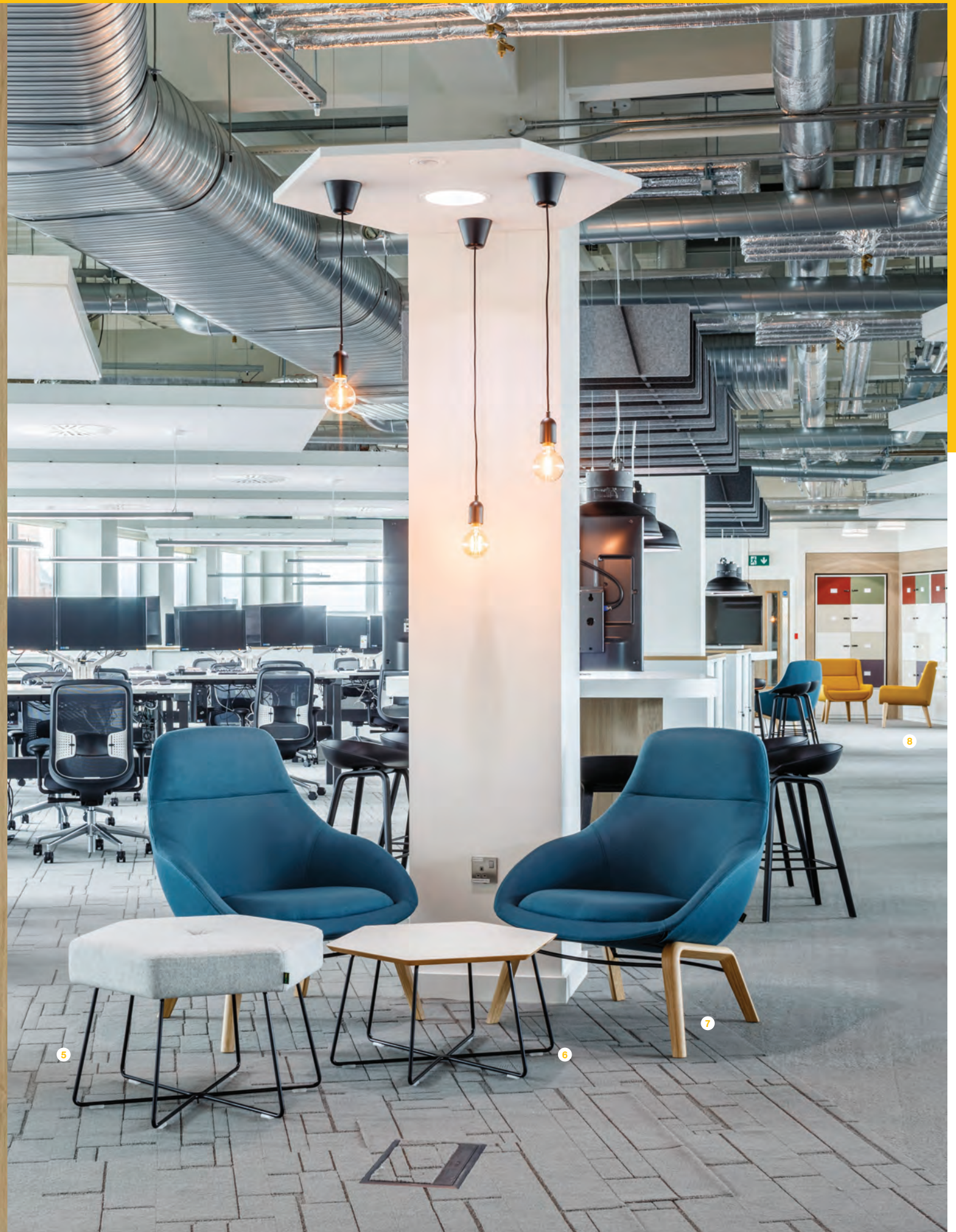

Government Contact Centre
Manchester, UK



learning



1

Etsy
New York, USA



working



Nielsen
Tel Aviv, Israel



learning



break out



Herman Miller Showroom
London, UK

Technology Company

Minnesota, USA





WSP
Birmingham, UK



University of Northampton
Northampton, UK

AutoRek

Glasgow, UK





meeting

Veracruz Concert Hall

Foro Boca, Mexico





Rudding Park
Harrogate, UK

customisation





products

A double page spread per product range to break down the range options in detail

60	Trace Small Tables	110	Viv 4 Star / 5 Star
62	Fold Steel Leg Tables	112	Viv Highback / Highback Lounge
64	Frog Tables	114	Bounce Chair
66	Dalby Wooden Leg Coffee and Cafe Tables	116	Always Chair
78	Dalby Wooden Leg Tables	118	Always 4 Star / 5 Star
70	Ped Table	120	Always Lounge Chair
72	Megaped Table	122	Fiji Chair / Sofa
74	Ali Table	124	Hush Low Chair
76	Knot Table	126	Hush Low Sofa
78	Riley Table	128	Hush Chair
80	New Hudson Coatstand	130	Hush Sofa
84	Sideboard Storage	132	Cloud Quilt Armchair / Sofa
86	Pollen Stool / Table	134	Cloud Plain Armchair / Sofa
88	Pinch Stool	136	Cloud Booth Seating
90	Lasso Seating	138	Cloud Desk
92	Construct Low Stool / Barstool	140	Pullman Chair
94	Polly Chair / Barstool	142	Pullman Sofa
96	Polly 4 Star / 5 Star	144	Pullman Booth
98	Polly Wood Chair / Armchair / Barstool	146	Hue Seating
100	New Ruby Wood Chair / Barstool	148	Rhyme Modular Seating
102	New Ruby Chair / Barstool	150	Busby Chair
104	New Ruby 4 Star / 5 Star	152	Portion Chair / Sofa / Bench
106	Viv Wood Chair / Lounge / Barstool	154	Hatch Modular Seating
108	Viv Chair / Lounge / Barstool	156	Symbol Modular Seating
		158	Clyde Club Chair / Sofa / Bench

trace

Small Table

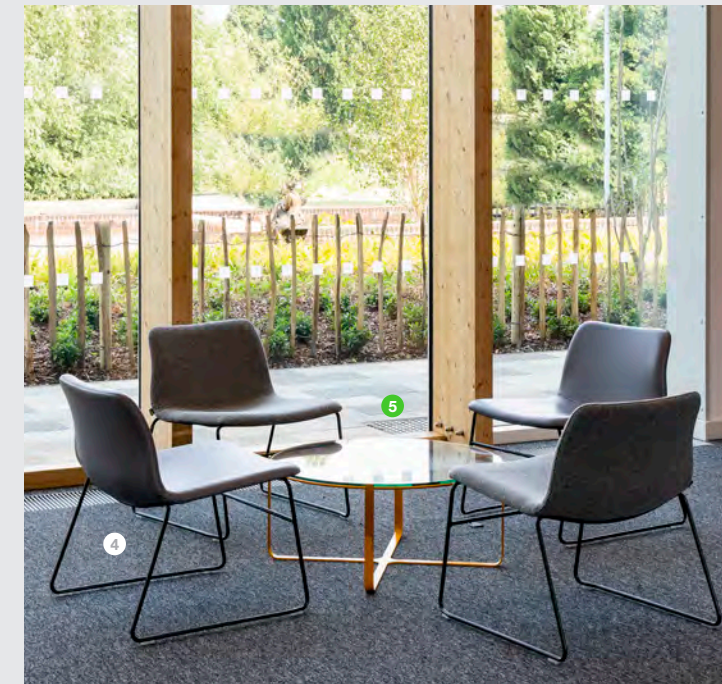

About Trace

The Trace table range is an unmistakable product in the naughtone range. Traditionally seen with a clear glass top, Trace works equally well solid materials recessed flush into the steel frame. The repetition of shapes makes Trace an exquisitely balanced form, whether it's a coffee table or meeting table.

Compliance

- SCS Indoor Advantage™ Gold Certificate
- FSC® certified products available upon request
- naughtone is FISP and ISO14001 certified
- Our tables are designed to meet or exceed all EN performance requirements per BS EN 15372:2016

Sizes

All dimensions quoted are rounded to the nearest 5mm or nearest 1/2 inch

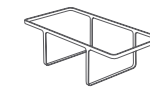

TRACT
Trace Coffee Table
mm
W1100 D550 H350
inch
W43 D21.5 H14

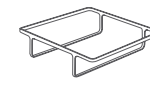

TRASQ
Trace Square Coffee Table
mm
W850 D850 H250
inch
W33.5 D33.5 H10



TRAST
Trace Side Table
mm
W450 D300 H450
inch
W17.5 D12 H17.5



TRA600D
Trace Coffee Table
600 Circular
mm
Dia 600 H350
inch
Dia 23.5 H14



TRA800D
Trace Coffee Table
800 Circular
mm
Dia 800 H350
inch
Dia 31.5 H14

Top Options



White / Black MFMDF
Circular tables matching edge band square edge



Clear toughened glass
Circular tables have a square polished edge



White marble
Circular tables have a square polished edge



Oak veneer
Circular tables matching veneered square edge



Walnut veneer
Circular tables matching veneered square edge



Forbo Lino
8 x colours available
Circular tables have a square polished MDF edge



Reverse painted glass
Black / Opti-white
Circular tables have a square polished edge



Reverse painted glass
in naughtone RAL colours
Circular tables have a square polished edge

Base Options



White / Black Powder Coated Base
Standard



RAL Powder Coated Base
naughtone Colours

naughtone RAL Colours



fold

Steel Leg Table



About Fold

Strong and elegant, the Fold range is carefully proportioned to provide a simple and customisable surface. Taking its name from the folded steel frame, Fold is a low statement product that can be used with any chair or bench.

Compliance

- SCS Indoor Advantage™ Gold Certificate
- FSC®certified products available upon request
- naughtone is FISP and ISO14001 certified
- Our tables are designed to meet or exceed all EN performance requirements per BS EN 15372:2016

Sizes

All dimensions quoted are rounded to the nearest 5mm or nearest 1/2 inch

FLD12D Fold 1200 Circular Table mm Dia 1200 H 750 inch Dia 47.5 H 29.5	FLD14D Fold 1400 Circular Table mm Dia 1400 H 750 inch Dia 55 H 29.5	FLD16D Fold 1600 Circular Table mm Dia 1600 H 750 inch Dia 63 H 29.5
FLD16X8 Fold 1600 x 800 Table mm W 1600 D 800 H 750 inch W 63 D 31.5 H 29.5	FLD18X8 Fold 1800 x 800 Table mm W 1800 D 800 H 750 inch W 71 D 31.5 H 29.5	FLD20X9 Fold 2000 x 900 Table mm W 2000 D 900 H 750 inch W 79 D 35.5 H 29.5
FLD22X9 Fold 2200 x 900 Table mm W 2200 D 900 H 750 inch W 87 D 35.5 H 29.5	FLD24X10 Fold 2400 x 1000 Table mm W 2400 D 1000 H 750 inch W 94.5 D 39 H 29.5	FLD24X12 Fold 2400 x 1200 Table mm W 2400 D 1200 H 750 inch W 94.5 D 47.5 H 29.5
FLD28 Fold 6 Leg Table 2800 mm W 2800 D 1200 H 750 inch W 110 D 47.5 H 29.5	FLD32 Fold 6 Leg Table 3200 mm W 3200 D 1200 H 750 inch W 126 D 47.5 H 29.5	
FLD16BH Fold Bar Height Table 1600 mm W 1600 D 800 H 1000 inch W 63 D 31.5 H 39.5	FLD18BH Fold Bar Height Table 1800 mm W 1800 D 800 H 1000 inch W 71 D 31.5 H 39.5	FLD20BH Fold Bar Height Table 2000 mm W 2000 D 900 H 1000 inch W 79 D 35.5 H 39.5
FLD22BH Fold Bar Height Table 2200 mm W 2200 D 900 H 1000 inch W 87 D 35.5 H 39.5	FLD28BH Fold 6 Leg Bar Height Table 2800 mm W 2800 D 1200 H 1000 inch W 110 D 47.5 H 39.5	FLD32BH Fold 6 Leg Bar Height Table 3200 mm W 3200 D 1200 H 1000 inch W 126 D 47.5 H 39.5

Base Finishes

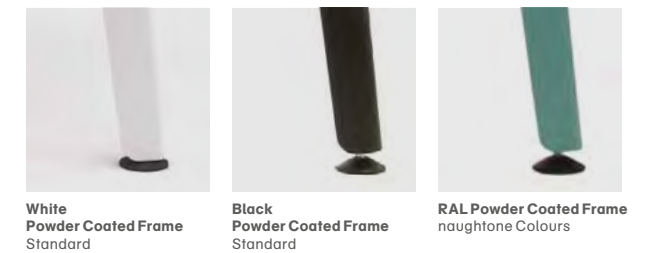

Top Options

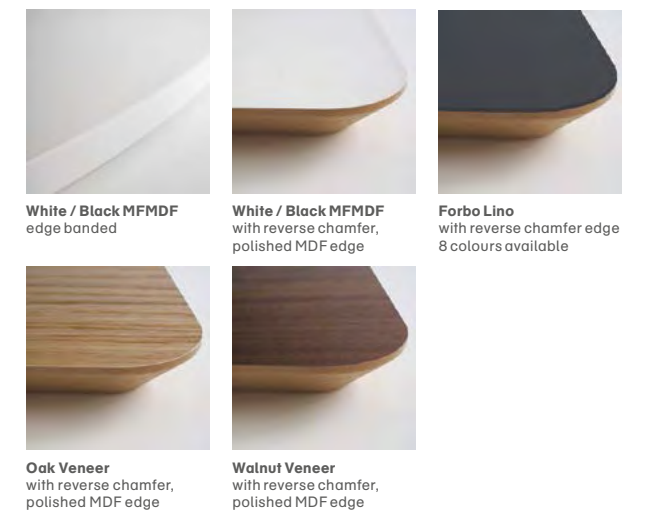

Power and Data Options

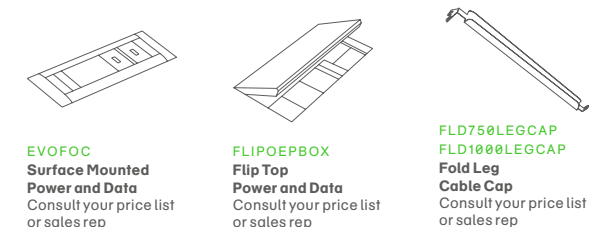

naughtone RAL Colours





frog
Table

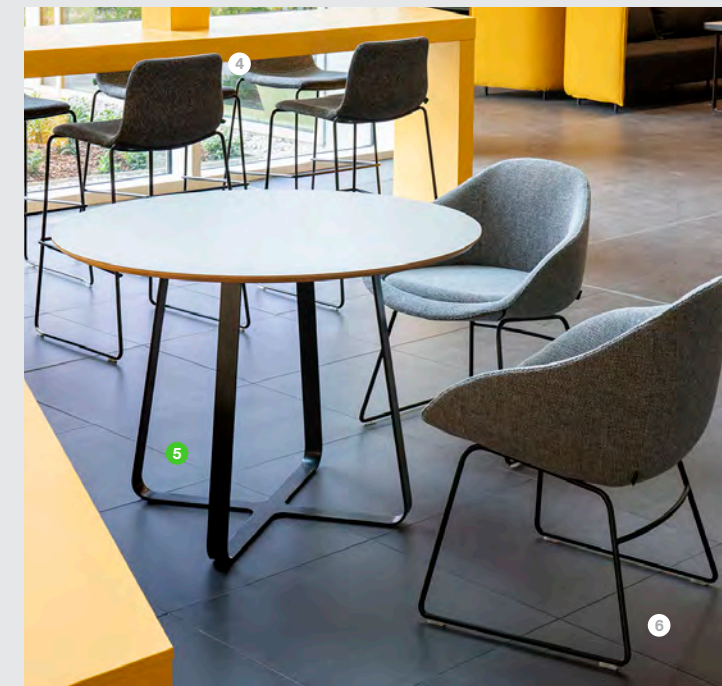

About Frog

Frog is a classically elegant yet functional table that is visually light and uncluttered. The base pays careful attention to the scale of the material and repetition of bends, making it a great choice for the workplace, restaurants or in the home.

Compliance

- SCS Indoor Advantage™ Gold Certificate
- FSC®certified products available upon request
- naughtone is FISP and ISO14001 certified
- Our tables are designed to meet or exceed all EN performance requirements per BS EN 15372:2016

Sizes

All dimensions quoted are rounded to the nearest 5mm or nearest 1/2 inch



FRG650D
Frog Table 650 Circular
mm Dia 650 H 750
inch Dia 25.5 H 29.5



FRG650S
Frog Table 650 Square
mm W 650 D 650 H 750
inch W 25.5 D 25.5 H 29.5



FRG850D
Frog Table 850 Circular
mm Dia 850 H 750
inch Dia 33.5 H 29.5



FRG850S
Frog Table 850 Square
mm W 850 D 850 H 750
inch W 33.5 D 33.5 H 29.5



FRG1050D
Frog Table 1050 Circular
mm Dia 1050 H 750
inch Dia 41.5 H 29.5

Base Finishes



White / Black
Powder Coated Frame
Standard



RAL Powder Coated Frame
naughtone Colours

Top Options



White / Black MFMDf
edge banded



White / Black MFMDf
with reverse chamfer,
polished MDF edge



Forbo Lino
with reverse chamfer edge
8 colours available



Oak Veneer
with reverse chamfer,
polished MDF edge



Walnut Veneer
with reverse chamfer,
polished MDF edge



dalby

Wooden Leg Coffee and Cafe Table



About Dalby

As your newest old friend, the Dalby table will effortlessly inject warmth and quality into an interior. Dalby provides a practical and robust surface making it ideal for the hospitality industry, or the home. Built from solid materials, Dalby will last as long as it's timeless aesthetic endures.

Compliance

- SCS Indoor Advantage™ Gold Certificate
- FSC® certified products available upon request
- naughtone is FISP and ISO14001 certified
- Our tables are designed to meet or exceed all EN performance requirements per BS EN 15372:2016

Sizes

All dimensions quoted are rounded to the nearest 5mm or nearest 1/2 inch



DAL650DL
Dalby 650 Circular Coffee Table
mm Dia 650 H 350
inch Dia 25.5 H 14



DAL650SL
Dalby 650 Square Coffee Table
mm W 650 D 650 H 350
inch W 25.5 D 25.5 H 14



DAL850DL
Dalby 850 Circular Coffee Table
mm Dia 850 H 350
inch Dia 33.5 H 14



DAL850SL
Dalby 850 Square Coffee Table
mm W 850 D 850 H 350
inch W 33.5 D 33.5 H 14



DAL11X55L
Dalby Rectangular Coffee Table
mm W 1100 D 550 H 350
inch W 43.5 D 21.5 H 14



DAL350D
Dalby 350 Circular Side Table
mm Dia 350 H 550
inch Dia 14 H 21.5



DAL350S
Dalby 350 Square Side Table
mm W 350 D 350 H 550
inch W 14 D 14 H 21.5



DAL650S
Dalby 650 Square Cafe Table
mm W 650 D 650 H 750
inch W 25.5 D 25.5 H 29.5



DAL850D
Dalby 850 Circular Cafe Table
mm Dia 850 H 750
inch Dia 33.5 H 29.5



DAL850S
Dalby 850 Square Cafe Table
mm W 850 D 850 H 750
inch W 33.5 D 33.5 H 29.5

Base Finishes



Solid Oak
Matt lacquered



Walnut
Matt lacquered

Top Options



White / Black MFMDF
edge banded



White / Black MFMDF
with reverse chamfer,
polished MDF edge



Forbo Lino
with reverse chamfer edge
8 colours available



Oak Veneer
with reverse chamfer,
polished MDF edge



Walnut Veneer
with reverse chamfer,
polished MDF edge

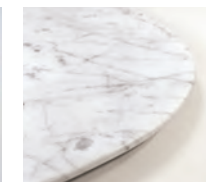

White Carrara Marble
with reverse chamfer
Coffee tables only

dalby

Wooden Leg Table

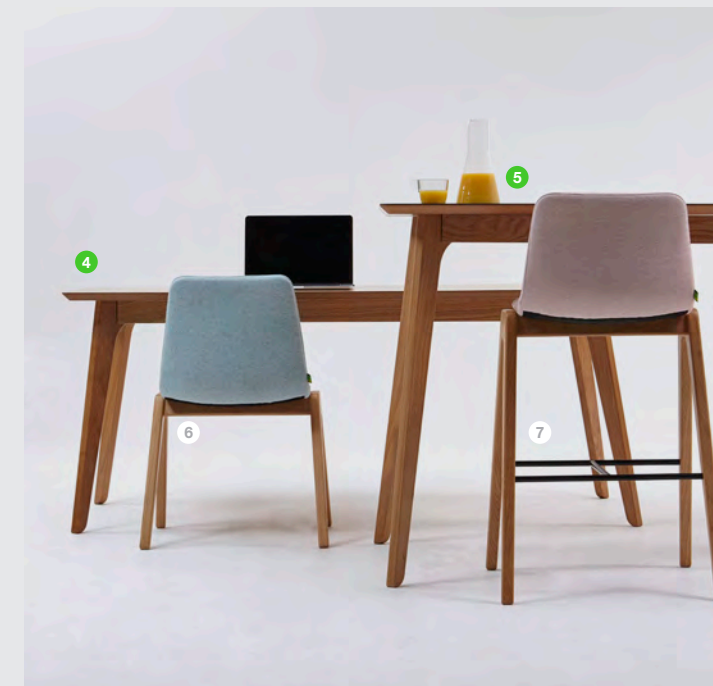

About Dalby

















As your newest old friend, the Dalby table will effortlessly inject warmth and quality into an interior. Dalby provides a practical and robust surface making it ideal for the hospitality industry, or the home. Built from solid materials, Dalby will last as long as it's timeless aesthetic endures.

Compliance

- SCS Indoor Advantage™ Gold Certificate
- FSC® certified products available upon request
- naughtone is FISP and ISO14001 certified
- Our tables are designed to meet or exceed all EN performance requirements per BS EN 15372:2016

Sizes

All dimensions quoted are rounded to the nearest 5mm or nearest 1/2 inch

 <p>DAL12DIA Dalby 1200 Circular Table mm Dia 1200 H 750 inch Dia 47.5 H 29.5</p>	 <p>DAL14DIA Dalby 1400 Circular Table mm Dia 1400 H 750 inch Dia 55 H 29.5</p>	 <p>DAL16DIA Dalby 1600 Circular Table mm Dia 1600 H 750 inch Dia 63 H 29.5</p>
 <p>DAL16X8 Dalby 1600x800 Table mm W 1600 D 800 H 750 inch W 63 D 31.5 H 29.5</p>	 <p>DAL18X8 Dalby 1800x800 Table mm W 1800 D 800 H 750 inch W 71 D 31.5 H 29.5</p>	 <p>DAL20X9 Dalby 2000x900 Table mm W 2000 D 900 H 750 inch W 79 D 35.5 H 29.5</p>
 <p>DAL22X9 Dalby 2200x900 Table mm W 2200 D 900 H 750 inch W 87 D 35.5 H 29.5</p>	 <p>DAL24X10 Dalby 2400x1000 Table mm W 2400 D 1000 H 750 inch W 94.5 D 39.5 H 29.5</p>	 <p>DAL24X12 Dalby 2400x1200 Table mm W 2400 D 1200 H 750 inch W 94.5 D 47.5 H 29.5</p>
 <p>DAL28X12 Dalby 6 Leg Table 2800 mm W 2800 D 1200 H 750 inch W 110 D 47.5 H 29.5</p>	 <p>DAL32X12 Dalby 6 Leg Table 3200 mm W 3200 D 1200 H 750 inch W 126 D 47.5 H 29.5</p>	
 <p>DAL16BH Dalby Bar Height Table 1600 mm W 1600 D 800 H 1000 inch W 63 D 31.5 H 39</p>	 <p>DAL18BH Dalby Bar Height Table 1800 mm W 1800 D 800 H 1000 inch W 71 D 31.5 H 39</p>	 <p>DAL20BH Dalby Bar Height Table 2000 mm W 2000 D 900 H 1000 inch W 79 D 35.5 H 39</p>
 <p>DAL22BH Dalby Bar Height Table 2200 mm W 2200 D 900 H 1000 inch W 87 D 35.5 H 39</p>	 <p>DAL28BH Dalby 6 Leg Bar Height Table 2800 mm W 2800 D 1200 H 1000 inch W 110 D 47.5 H 39</p>	 <p>DAL32BH Dalby 6 Leg Bar Height Table 3200 mm W 3200 D 1200 H 1000 inch W 126 D 47.5 H 39</p>

Base Finishes



Top Options

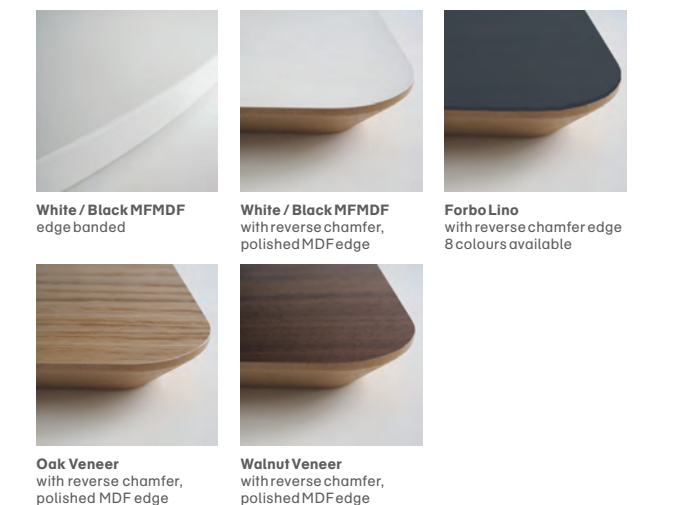

Power and Data Options

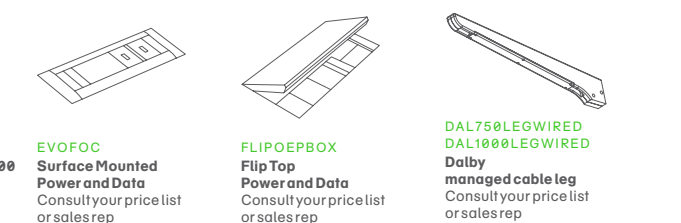



ped
Table











About Ped

A simple thing done well, the Ped table is versatile and unobtrusive with its soft square shaped base. Robust and strong, Ped performs in most environments from hospitality to the workplace.

Compliance

- SCS Indoor Advantage™ Gold Certificate
- FSC®certified products available upon request
- naughtone is FISP and ISO14001 certified
- Our tables are designed to meet or exceed all EN performance requirements per BS EN 15372:2016

Sizes All dimensions quoted are rounded to the nearest 5mm or nearest 1/2 inch

 <p>PED650DL Ped 650 Circular Coffee Table mm Dia 650 H 450 inch Dia 25.5 H 17.5</p>	 <p>PED650SL Ped 650 Square Coffee Table mm W 650 D 650 H 450 inch W 25.5 D 25.5 H 17.5</p>	
 <p>PED650D Ped 650 Circular Table mm Dia 650 H 750 inch Dia 25.5 H 29.5</p>	 <p>PED650S Ped 650 Square Table mm W 650 D 650 H 750 inch W 25.5 D 25.5 H 29.5</p>	
 <p>PED850D Ped 850 Circular Table mm Dia 850 H 750 inch Dia 33.5 H 29.5</p>	 <p>PED850S Ped 850 Square Table mm W 850 D 850 H 750 inch W 33.5 D 33.5 H 29.5</p>	 <p>PED1050D Ped 1050 Circular Table mm Dia 1050 H 750 inch Dia 41.5 H 29.5</p>
 <p>PED650DH Ped 650 Circular Poseur Table mm Dia 650 H 1000 inch Dia 25.5 H 39.5</p>	 <p>PED650SH Ped 650 Square Poseur Table mm W 650 D 650 H 1000 inch W 25.5 D 25.5 H 39.5</p>	

Base Finishes



Top Options

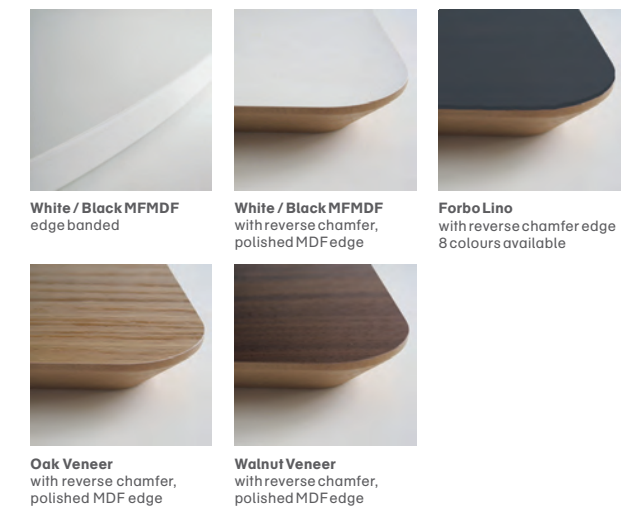



megaped

Table



About Megaped

With a pared down design and robust construction, the Megaped table supports large table tops. Megaped is perfectly suited for workplace meetings or large functions. The minimalistic soft square shaped base and hollow stem allows for maximum leg space and can be fitted with power and data.

Compliance

- SCS Indoor Advantage™ Gold Certificate
- FSC® certified products available upon request
- naughtone is FISP and ISO14001 certified
- Our tables are designed to meet or exceed all EN performance requirements per BS EN 15372:2016

Sizes

All dimensions quoted are rounded to the nearest 5mm or nearest 1/2 inch

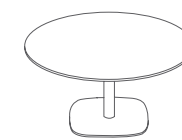

MP105D
Megaped 1050 Circular Table
mm
Dia 1050 H 750
inch
Dia 41.5 H 29.5

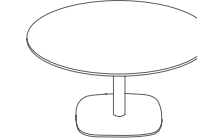

MP12D
Megaped 1200 Circular Table
mm
Dia 1200 H 750
inch
Dia 47 H 29.5

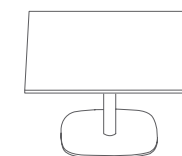

MP115S
Megaped 1150 Square Table
mm
W 1150 D 1150 H 750
inch
W 45.5 D 45.5 H 29.5

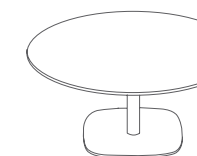

MP15D
Megaped 1500 Circular Table
mm
Dia 1500 H 750
inch
Dia 59 H 29.5

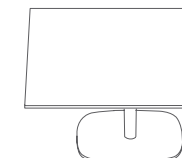

MP150S
Megaped 1500 Square Table
mm
W 1500 D 1500 H 750
inch
W 59 D 59 H 29.5



MP20D
Megaped 2000 Circular Table
mm
Dia 2000 H 750
inch
Dia 79 H 29.5

Base Finishes



White Powder Coated
Base and Stem
Standard



Black Powder Coated
Base and Stem
Standard



RAL Powder Coated
Base and Stem
naughtone Colours

Top Options



White / Black MFMDf
edge banded



White / Black MFMDf
with reverse chamfer,
polished MDF edge



Forbo Lino
with reverse chamfer edge
8 colours available



Oak Veneer
with reverse chamfer,
polished MDF edge



Walnut Veneer
with reverse chamfer,
polished MDF edge

Power and Data Options



EVOPORT
Port Unit
Power and Data
Consult your price list
or sales rep



OEPIX
Pixel
Power and Data
Consult your price list
or sales rep

naughtone RAL Colours



ali ^{New}
Table













About Ali

Ali is the most recent addition to naughtone's range of coffee, café and poseur tables, working particularly well in the hospitality and education sectors. Ali has a robust die cast aluminium base that is lightweight and perfectly complements our range of 4 star based chairs, within an abundance of environments.

Compliance

- SCS Indoor Advantage™ Gold Certificate
- FSC®certified products available upon request
- naughtone is FISP and ISO14001 certified
- Our tables are designed to meet or exceed all EN performance requirements per BS EN 15372:2016

Sizes All dimensions quoted are rounded to the nearest 5mm or nearest 1/2 inch

 ALI650DL Ali 650 Circular Coffee Table mm Dia 650 H 450 inch Dia 25.5 H 17.5	 ALI650SL Ali 650 Square Coffee Table mm W 650 D 650 H 450 inch W 25.5 D 25.5 H 17.5	 ALI850DL Ali 850 Circular Coffee Table mm Dia 850 H 450 inch Dia 33.5 H 17.5
 ALI850SL Ali 850 Square Coffee Table mm W 850 D 850 H 450 inch W 33.5 D 33.5 H 17.5	 ALI650D Ali 650 Circular Cafe Table mm Dia 650 H 750 inch Dia 25.5 H 29.5	 ALI650S Ali 650 Square Cafe Table mm W 650 D 650 H 750 inch W 25.5 D 25.5 H 29.5
 ALI850S Ali 850 Square Cafe Table mm W 850 D 850 H 750 inch W 33.5 D 33.5 H 29.5	 ALI650DH Ali 650 Circular Poseur Height Table mm Dia 650 H 1000 inch Dia 25.5 H 39.5	 ALI650SH Ali 650 Square Poseur Height Table mm W 650 D 650 H 1000 inch W 25.5 D 25.5 H 39.5
 ALI850DH Ali 850 Circular Poseur Height Table mm Dia 850 H 1000 inch Dia 33.5 H 39.5		

Top Options

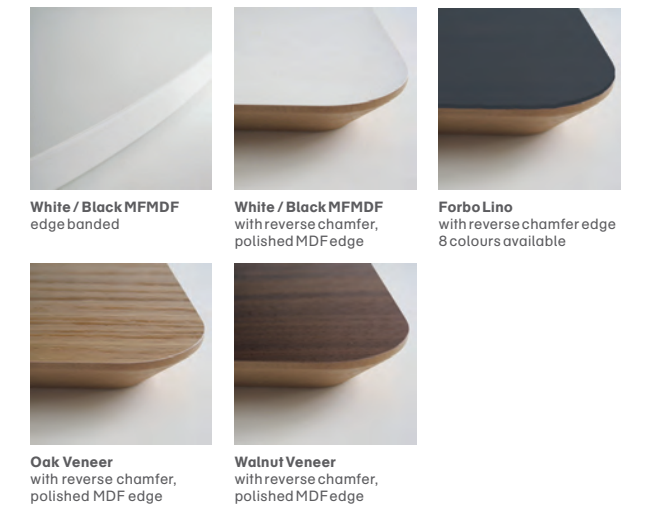

Base Finishes

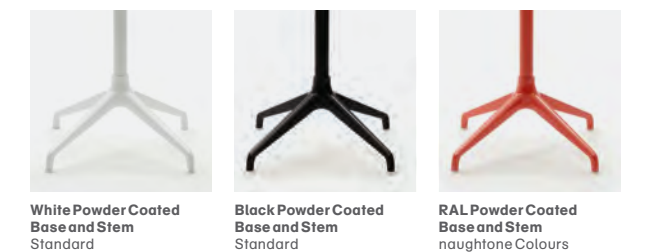

knot

Table



About Knot

Taking its name from the cartoon like aesthetic of the knotted tube stem, Knot is the perfect height and scale to work with a multitude of seating within the workplace, education, hospitality and domestic environments.

Compliance

- SCS Indoor Advantage™ Gold Certificate
- FSC®certified products available upon request
- naughtone is FISP and ISO14001 certified
- Our tables are designed to meet or exceed all EN performance requirements per BS EN 15372:2016

Sizes

All dimensions quoted are rounded to the nearest 5mm or nearest 1/2 inch



KNO50X40
Knot Rectangular Table
mm
W 400 D 500 H 650
inch
W 15.5 D 19.5 H 25.5



KNO550D
Knot 550 Circular Table
mm
Dia 550 H 650
inch
Dia 21.5 H 25.5

Top Options



White / Black MFMDf
with reverse chamfer,
polished MDF edge



Forbo Lino
with reverse chamfer edge
8 colours available



Oak Veneer
with reverse chamfer,
polished MDF edge



Walnut Veneer
with reverse chamfer,
polished MDF edge

Base Finishes

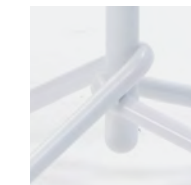

White Powder Coated Base
Standard



Black Powder Coated Base
Standard



RAL Powder Coated Base
naughtone Colours

riley

Table

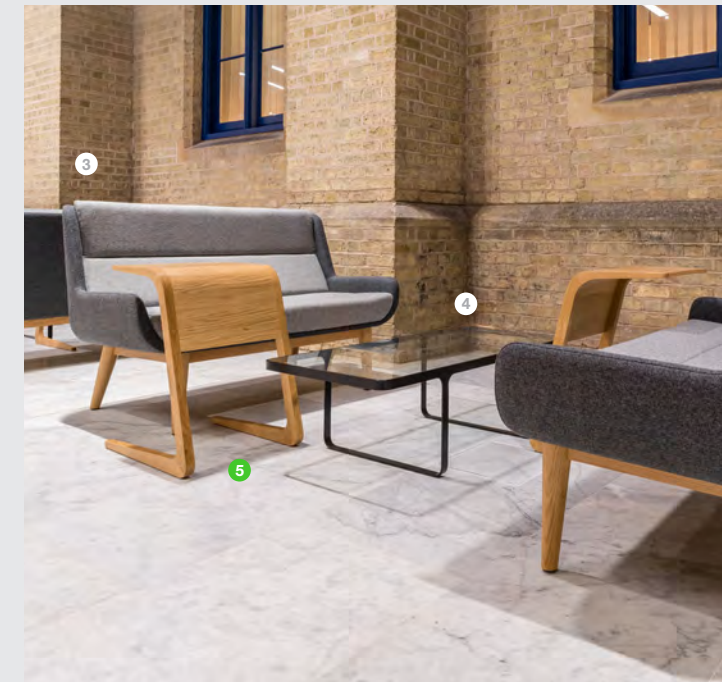

About Riley

Riley is a staple in the naughtone portfolio; a beautifully crafted, solid wood pull up table that is a sleek and functional addition to any environment. The wooden table is designed to slide perfectly over benches, or sofa and arm chairs.

Compliance

- SCS Indoor Advantage™ Gold Certificate
- FSC®certified products available upon request
- naughtone is FISP and ISO14001 certified
- Our tables are designed to meet or exceed all EN performance requirements per BS EN 15372:2016

Size All dimensions quoted are rounded to the nearest 5mm or nearest 1/2 inch

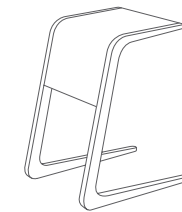

RILEY
 Riley Table
 mm
 W 450 D 550 H 650
 inch
 W 17.5 D 21.5 H 25.5

Finishes



Oak

Walnut

hudson

Coatstand

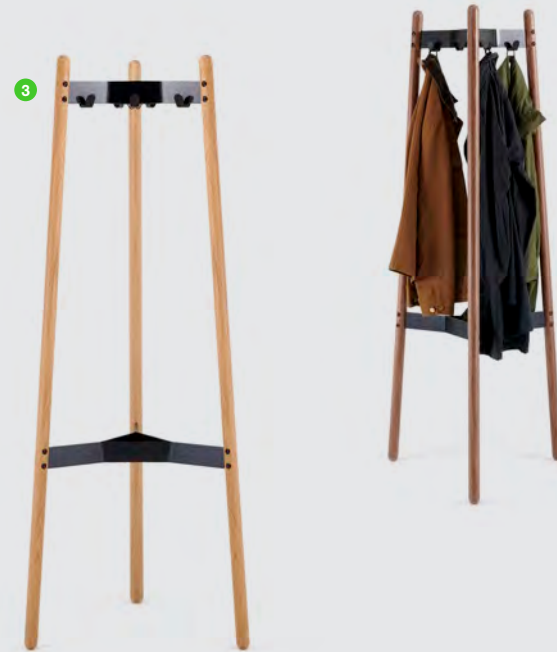

About Hudson

Hudson is named after the iconic housekeeper of 221B Baker Street. As the keeper of the coats, Hudson maintains its presence in the room even when filled with coats.

Functional and beautiful, the Hudson coat stand has a residential appeal that perfectly complements other products in the naughtone range that feature oak, walnut or folded steel.

Compliance

- SCS Indoor Advantage™ Gold Certificate
- FSC®certified products available upon request
- naughtone is FISP and ISO14001 certified

Size

All dimensions quoted are rounded to the nearest 5mm or nearest 1/2 inch

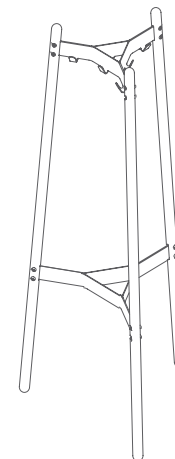

HUDSON
Hudson Coatstand
mm
W640 D560 H1620
inch
W25 D22 H63.5

Finishes



Black / White
Powder Coated Steel Frame
Standard

Oak Legs
Standard

Walnut Legs

sideboard

Storage



About Sideboard

Sideboard works effortlessly as a storage unit, whilst sitting un-noticed in a space. Equally, Sideboard holds its colour very well and can be a great way to add a splash of colour to an interior.

Compliance

- SCS Indoor Advantage™ Gold Certificate
- FSC® certified products available upon request
- naughtone is FISP and ISO14001 certified
- Our storage units are designed to meet or exceed all EN performance requirements per BS EN 16121:2013

Size

All dimensions quoted are rounded to the nearest 5mm or nearest 1/2 inch

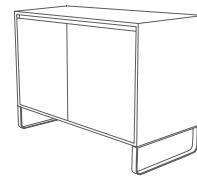

SB12
Sideboard 1200
mm
W 1200 D 500 H 750
inch
W 47 D 19.5 H 29.5

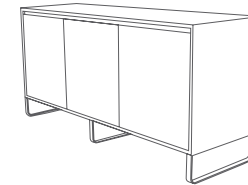

SB16
Sideboard 1600
mm
W 1600 D 500 H 750
inch
W 63 D 19.5 H 29.5

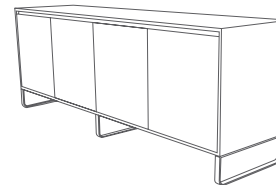

SB20
Sideboard 2000
mm
W 2000 D 500 H 750
inch
W 79 D 19.5 H 29.5

Other Options



AV Cut-Outs

Finish Options



Lacquered MDF
in naughtone RAL Colours



Walnut Veneer



Oak Veneer

Top Options



Back Painted Glass



Marble



Walnut / Oak Veneer

Base Options / Finishes



White Powder Coated
Sled Base
Standard



Black Powder Coated
Sled Base
Standard



RAL Powder Coated
Sled Base
naughtone Colours

naughtone RAL Colours





pollen
Stool

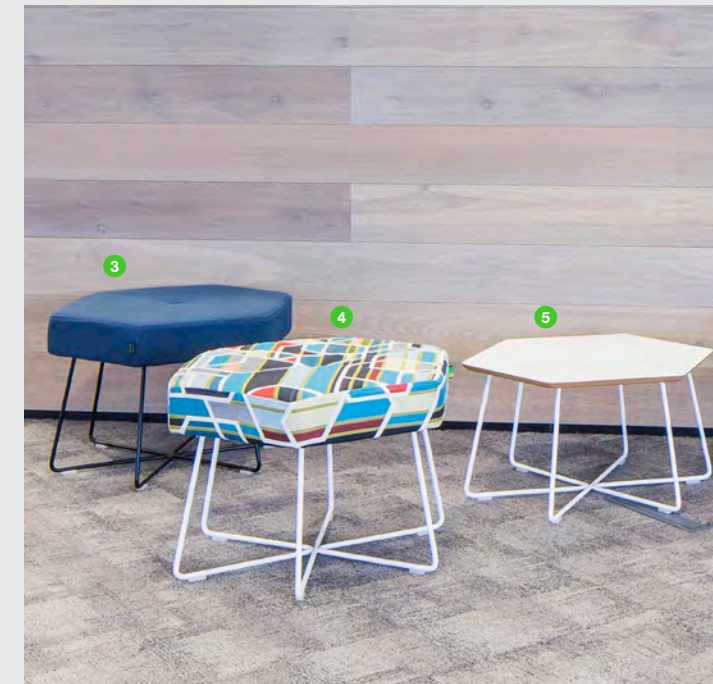

About Pollen

The hexagon is a naturally repeating and pleasing shape that lends itself to being used in small clusters, straight lines or tucked into corners. Pollen is a truly dynamic seating and table system.

Compliance

- SCS Indoor Advantage™ Gold Certificate
- FSC®certified products available upon request
- naughtone is FISP and ISO14001 certified
- Our stools are designed to meet or exceed all EN performance requirements per **BS EN 16139:2013**
- Our tables are designed to meet or exceed all EN performance requirements per **BS EN 15372:2016**

Sizes All dimensions quoted are rounded to the nearest 5mm or nearest 1/2 inch

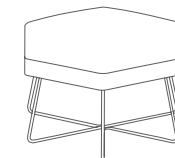

POLST
Pollen Stool
mm
W685 D600 H450 Seat 450
inch
W27 D23.5 H17.5 Seat 17.5



POLSTBT
Pollen Buttoned Stool
mm
W685 D600 H450 Seat 450
inch
W27 D23.5 H17.5 Seat 17.5



POLTAB
Pollen Table
mm
W685 D600 H350
inch
W27 D23.5 H14

Base Finishes

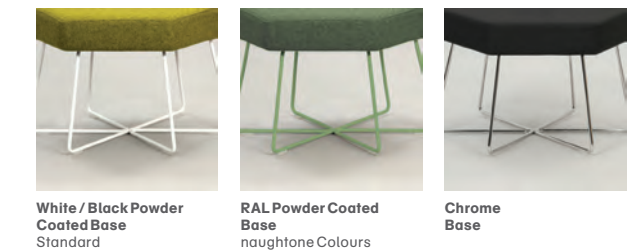
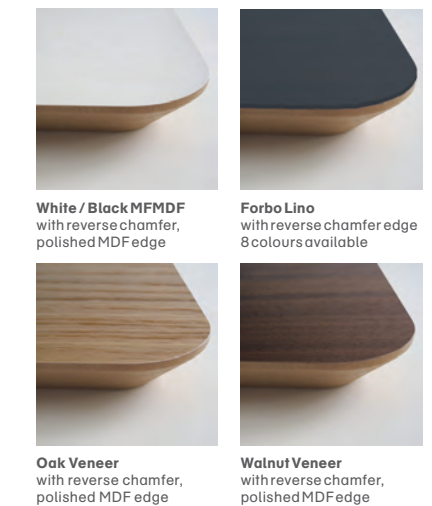
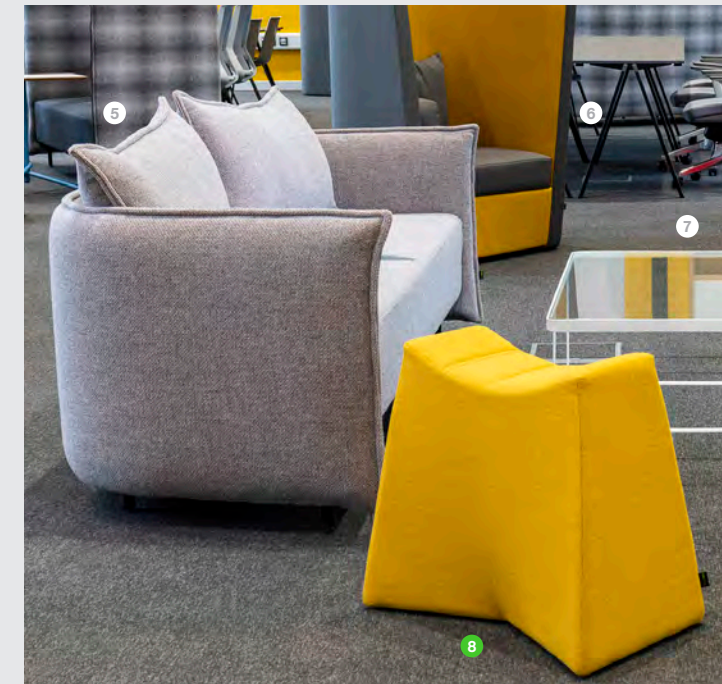

Table Top Options



pinch

Stool



About Pinch

Pinch is truly versatile, offering a comfortable seat whether used at a table, mingled with soft seating or scattered in a space. Pinch works brilliantly as functional and occasional seating, in public, educational or hospitality spaces.

Compliance

- SCS Indoor Advantage™ Gold Certificate
- FSC®certified products available upon request
- naughtone is FISP and ISO14001 certified
- Our stools are designed to meet or exceed all EN performance requirements per BS EN 16139:2013

Sizes

All dimensions quoted are rounded to the nearest 5mm or nearest 1/2 inch



PINST
Pinch Stool
mm
W550 D350 H500 Seat 450
inch
W21.5 D14 H19.5 Seat 17.5

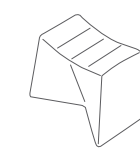

PINLO
Pinch Low Stool
mm
W600 D450 H400 Seat 350
inch
W23.5 D17.5 H16 Seat 14

Other Options

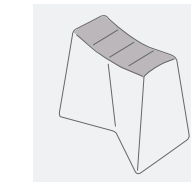

Two Tone
Seat Top / All Sides

lasso

Seating



About Lasso

Lasso is a collaborative seating and table system that can be easily moved to create clusters around the three seat stool. The Lasso seating range is ideally suited to project work within open spaces.

Compliance

- SCS Indoor Advantage™ Gold Certificate
- FSC® certified products available upon request
- naughtone is FISP and ISO14001 certified

Sizes

All dimensions quoted are rounded to the nearest 5mm or nearest 1/2 inch



LASST
Lasso Stool
mm
W 510 D 510 H 485 Seat 485
inch
W 20 D 20 H 19 Seat 19

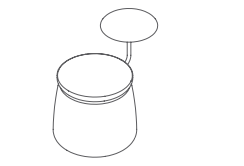

LASSTAB
Lasso Stool and Table
mm
W 510 D 725 H 705 Seat 485
inch
W 20 D 28.5 H 28 Seat 19

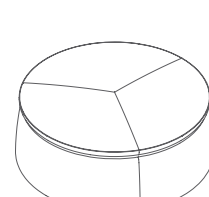

LAS3S
Lasso 3 Seat Stool
mm
W 1210 D 1210 H 500 Seat 485
inch
W 47.5 D 47.5 H 19.5 Seat 19



LAS3STAB
Lasso 3 Seat Stool and Tables
mm
W 1425 D 1465 H 705 Seat 485
inch
W 56 D 57.5 H 28 Seat 19

Table Options



White / Black MFMDf
with reverse chamfer,
polished MDF edge



Oak Veneer
with reverse chamfer,
polished MDF edge



Walnut Veneer
with reverse chamfer,
polished MDF edge

Ring / Tablet Ring Finishes



White / Black
Ring / Tablet Arm
Standard



RAL Powder Coated
Ring / Tablet Arm
naughtone Colours

Other Options



Two Tone
Body / Seat Top



construct

Low Stool and Barstool

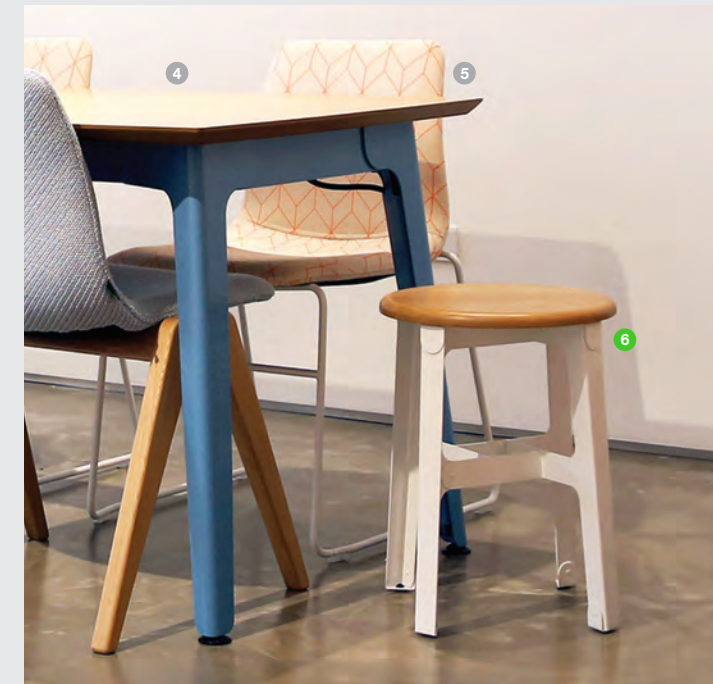

About Construct

The Construct range has an industrial aesthetic thanks to its folded steel frame and visible rivet construction. Paired with a simple solid wood top this stool really wears its construction method on its sleeve.

Compliance

- SCS Indoor Advantage™ Gold Certificate
- FSC®certified products available upon request
- naughtone is FISP and ISO14001 certified
- Our stools are designed to meet or exceed all EN performance requirements per BS EN 16139:2013

Sizes

All dimensions quoted are rounded to the nearest 5mm or nearest 1/2 inch



CONLO
Construct Low Stool
mm
W 385 D 385 H 450
inch
W 15 D 15 H 17.5

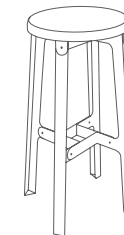

CONCHS
Construct Counter Height Stool
mm
W 425 D 425 H 660
inch
W 16.5 D 16.5 H 26

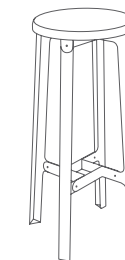

CONBS
Construct Barstool
mm
W 425 D 425 H 760
inch
W 16.5 D 16.5 H 29.5

Top Options



Solid Oak Seat



Solid Walnut Seat

Base Finishes



White Powder Coated Standard



Black Powder Coated Standard



RAL Powder Coated naughtone Colours

polly

Chair / Barstool

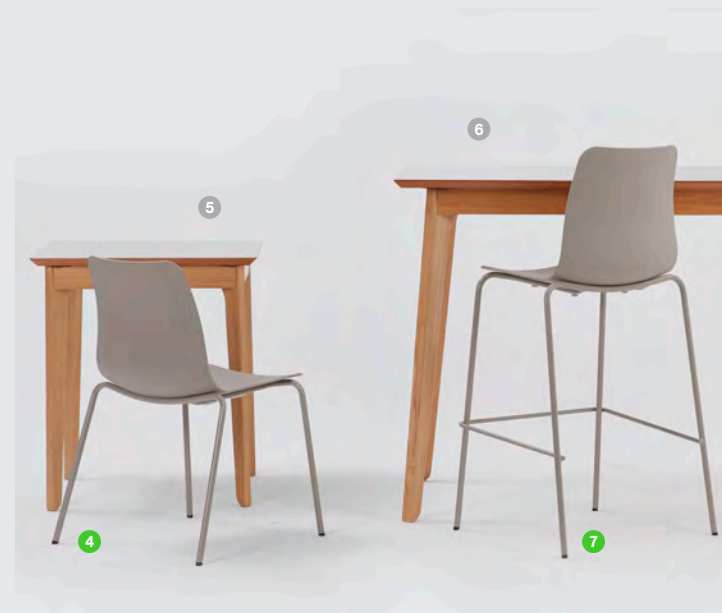





About Polly
 Polly takes its name from the material of which the comfortable and ergonomic seat shell is made; polypropylene. Providing very little visual detail as possible, Polly has subtle edge details, a soft texture and just the right amount of flex, all combined to provide a tactile and satisfying sitting experience.

Polly stacks neatly on the ground and on a designated stacking trolley.

- Compliance**
- SCS Indoor Advantage™ Gold Certificate
 - FSC® certified products available upon request
 - naughtone is FISP and ISO14001 certified
 - Our chairs are designed to meet or exceed all EN performance requirements per BS EN 16139:2013
 - Health Product Declaration (HPD) reports available

Sizes All dimensions quoted are rounded to the nearest 5mm or nearest 1/2 inch

 POLLYCHB4L Polly Chair 4 Leg Base mm W 513 D 530 H 785 Seat 450 inch W 20 D 21 H 31 Seat 17.5	 POLLYCHBSL Polly Chair Sled Base mm W 524 D 530 H 785 Seat 450 inch W 20.5 D 21 H 31 Seat 17.5	 POLLYCHBDL Polly Chair Dowel Base mm W 505 D 530 H 785 Seat 450 inch W 20 D 21 H 31 Seat 17.5
 POLLYCHBSB4L Polly Counter Height Stool on Sled Base mm W 568 D 536 H 1005 Seat 650 inch W 22.5 D 21 H 39.5 Seat 25.5	 POLLYBSB4L Polly Barstool 4 Leg mm W 568 D 536 H 1105 Seat 735 inch W 22.5 D 21 H 43.5 Seat 29	
 POLLYCHBSL Polly Counter Height Stool on Sled Base mm W 565 D 565 H 1005 Seat 650 inch W 22.5 D 22.5 H 39.5 Seat 25.5	 POLLYBSL Polly Barstool on Sled Base mm W 565 D 565 H 1100 Seat 735 inch W 22.5 D 22.5 H 43.5 Seat 29	

Base Finishes



Other Options

Seat Shell Colours

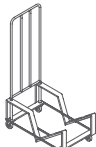

Stacking Trolley Available for Chairs Only

 STACKTRCOMP Stacking Trolley Black mm W 1010 D 595 H 1690 inch W 40 D 23.5 H 67	<p>Stacking Quantities</p> <p>Polly Chair 4 Leg Base On Stacking Trolley x 20</p> <p>Polly Chair Sled Base On Stacking Trolley x 20</p> <p>Polly Chair with seatpad On Stacking Trolley x 12</p>
--	---

polly

4 Star / 5 Star

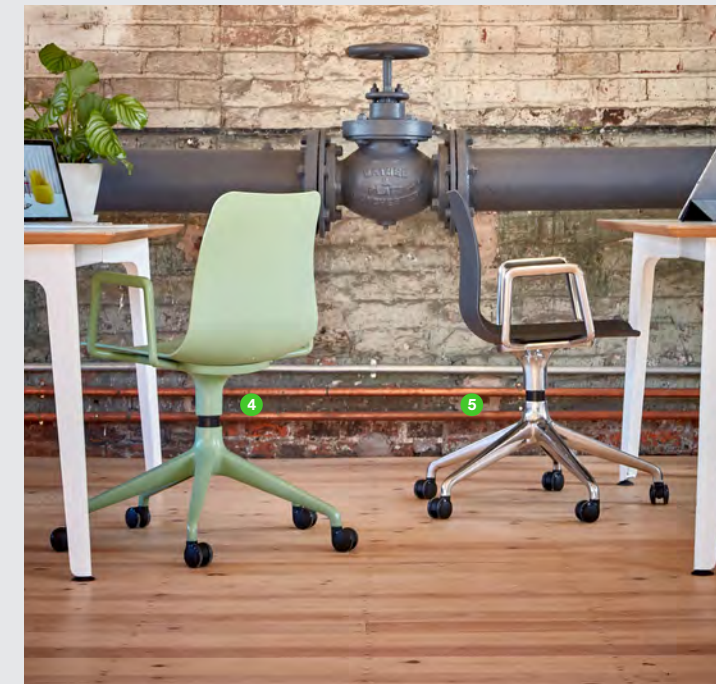

About Polly

Polly takes its name from the material of which the comfortable and ergonomic seat shell is made; polypropylene. Providing very little visual detail as possible, Polly has subtle edge details, a soft texture and just the right amount of flex, all combined to provide a tactile and satisfying sitting experience.

Compliance

- SCS Indoor Advantage™ Gold Certificate
- FSC® certified products available upon request
- naughtone is FISP and ISO14001 certified
- Our chairs are designed to meet or exceed all EN performance requirements per BS EN 16139:2013
- Health Product Declaration (HPD) reports available

Sizes

All dimensions quoted are rounded to the nearest 5mm or nearest 1/2 inch

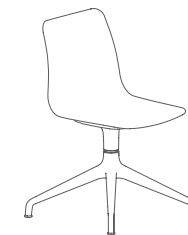

POLLYCH4S
Polly Chair
4 Star Base with Standard Glides
mm
W 500 D 530 H 785 Seat 450
inch
W 19.5 D 21 H 31 Seat 17.5

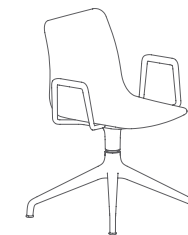

POLLYACH4S
Polly Armchair
4 Star Base with Standard Glides
mm
W 500 D 530 H 785 Seat 450
inch
W 19.5 D 21 H 31 Seat 17.5

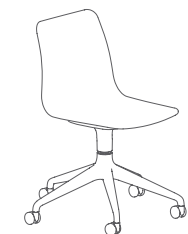

POLLYCH5S
Polly Chair
5 Star Base with Standard Castors
mm
W 635 D 530 H 785 Seat 450
inch
W 25 D 21 H 31 Seat 17.5

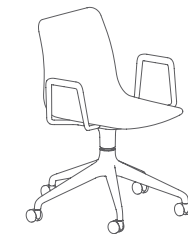

POLLYACH5S
Polly Armchair
5 Star Base with Standard Castors
mm
W 635 D 530 H 785 Seat 450
inch
W 25 D 21 H 31 Seat 17.5

Base Finishes



4 Star Base
White / Black / Polished

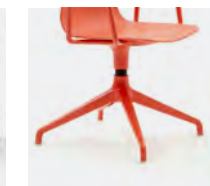

4 Star Base
RAL Powder Coated
naughtone Colours



5 Star Base
White / Black / Polished



5 Star Base
RAL Powder Coated
naughtone Colours

Other Options



5 Star Base
Gas Lift mechanism



Seatpad

Seat Shell Colours 2019



polly wood

Chair



About Polly Wood

Polly Wood is a direct reference to the honest materials used to create this product. Standing proud on a solid oak or walnut base, Polly Wood offers a very comfortable sit and an aesthetically pleasing shape, allowing it to blend effortlessly into any environment.

Compliance

- SCS Indoor Advantage™ Gold Certificate
- FSC®certified products available upon request
- naughtone is FISP and ISO14001 certified
- Our chairs are designed to meet or exceed all EN performance requirements per BS EN 16139:2013

Sizes

All dimensions quoted are rounded to the nearest 5mm or nearest 1/2 inch



POLLYCHBWD
Polly Wood Chair
mm
W545 D 485 H805 Seat 450
inch
W21.5 D 19 H 32 Seat 17.5



POLLYACHBWD
Polly Wood Armchair
mm
W545 D 485 H805 Seat 450
inch
W21.5 D 19 H 32 Seat 17.5



POLLYCHSWD
Polly Wood Counter Height Stool
mm
W565 D 510 H1010 Seat 660
inch
W22.5 D 20 H 40 Seat 26



POLLYBSWD
Polly Wood Barstool
mm
W575 D 555 H1085 Seat 750
inch
W22.5 D 22 H 42.5 Seat 29.5

Base Finishes



Solid Oak Base



Solid Walnut Base

Other Options



Seatpad

Seat Shell Colours 2020

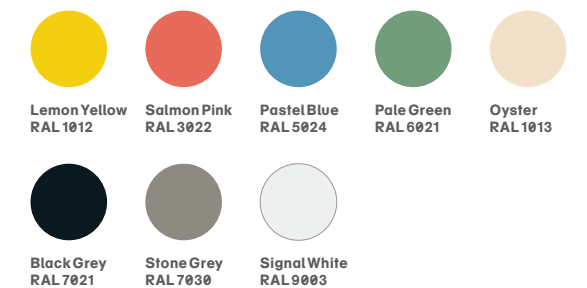

ruby wood

Chair / Barstool



About Ruby Wood

The Ruby Wood chair is simple and elegant. The broad appeal design has beautiful attention to detail as well as a supportive sitting position.

With a moulded polypropylene seat shell, Ruby Wood is wipeable, seamless and hardwearing, making it ideal for the workplace, education, hospitality and residential environments.

The generous use of solid hardwood (oak or walnut) in the base is a key characteristic of Ruby wood and provides a robust chair with a real sense of material and tactile value in the product.

Compliance

- SCS Indoor Advantage™ Gold Certificate
- FSC® certified products available upon request
- naughtone is FISP and ISO14001 certified
- Our chairs are designed to meet or exceed all EN performance requirements per **BS EN 16139:2013**

Sizes

All dimensions quoted are rounded to the nearest 5mm or nearest 1/2 inch

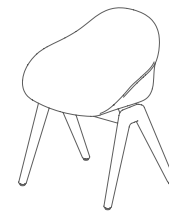

RUBYCHBD
Ruby Wood Chair
mm
W 610 D 530 H 800 Seat 445
inch
W 24 D 21 H 31.5 Seat 17.5



RUBYCHSWD
Ruby Wood Counter Height Stool
mm
W 610 D 530 H 1000 Seat 645
inch
W 24 D 21 H 35.5 Seat 25.5



RUBYBSWD
Ruby Wood Barstool
mm
W 610 D 530 H 1100 Seat 745
inch
W 24 D 21 H 43.5 Seat 29.5

Base Finishes



Solid Oak Base

Solid Walnut Base

Seat Shell Colours



1 Ruby Chair Dowel Base



4 Ruby Chair 4 Leg



Ruby Chair designed by naughtone 2020

About Ruby

The Ruby chair is simple and elegant. The broad appeal design has beautiful attention to detail as well as a supportive sitting position.

As a barstool, Ruby has a unique characteristic and offers an enhanced level of comfort and support at a higher posture.

With a moulded polypropylene seat shell, Ruby is wipeable, seamless and hardwearing, making it ideal for the workplace, education, hospitality and residential environments.

Compliance

- naughtone is FISP and ISO14001 certified
- Our chairs are designed to meet or exceed all EN performance requirements per BS EN 16139:2013

Sizes All dimensions quoted are rounded to the nearest 5mm or nearest 1/2 inch



RUBYCHB4L
Ruby Chair 4 Leg Base
mm
W 610 D 540 H 785 Seat 430
inch
W 24 D 21.5 H 31 Seat 17



RUBYCHBSL
Ruby Chair Sled Base
mm
W 610 D 530 H 785 Seat 430
inch
W 24 D 21 H 31 Seat 17



RUBYCHBDL
Ruby Chair Dowel Base
mm
W 610 D 530 H 785 Seat 430
inch
W 24 D 21 H 31 Seat 17



RUBYCHSB4L
Ruby Counter Height Stool
mm
W 610 D 530 H 995 Seat 640
inch
W 24 D 21 H 39 Seat 25



RUBYBSB4L
Ruby Barstool 4 Leg
mm
W 610 D 535 H 1095 Seat 640
inch
W 24 D 21 H 43 Seat 25



RUBYCHSB4L
Ruby Counter Height Stool on Sled Base
mm
W 610 D 540 H 995 Seat 640
inch
W 24 D 21.5 H 39 Seat 25



RUBYBSB4L
Ruby Barstool on Sled base
mm
W 610 D 565 H 1090 Seat 730
inch
W 24 D 22 H 43 Seat 28.5

Base Finishes



Steel 4 Leg
White / Black / Chrome



Steel 4 Leg
RAL Powder Coated
8 x Seat Shell Colours



Sled Base
White / Black / Chrome



Sled Base
RAL Powder Coated
8 x Seat Shell Colours



Dowel Base
Oak / Walnut

Seat Shell Colours



Lemon Yellow
RAL 1012

Salmon Pink
RAL 3022

Pastel Blue
RAL 5024

Pale Green
RAL 6021

Oyster
RAL 1013

Black Grey
RAL 7021

Stone Grey
RAL 7030

Signal White
RAL 9003



About Ruby

The Ruby chair is simple and elegant. The broad appeal design has beautiful attention to detail as well as a supportive sitting position.

With a moulded polypropylene seat shell, Ruby is wipeable, seamless and hardwearing, making it ideal for the workplace, education, hospitality and residential environments.

Compliance

- naughtone is **FISP** and **ISO14001** certified
- Our chairs are designed to meet or exceed all EN performance requirements per **BS EN 16139:2013**
- Health Product Declaration (HPD) reports available

Sizes All dimensions quoted are rounded to the nearest 5mm or nearest 1/2 inch



RUBYCH4S
Ruby Chair
with 4 Star base
mm
W 610 D 530 H 795 Seat 440
inch
W 24 D 21 H 31.5 Seat 17.5

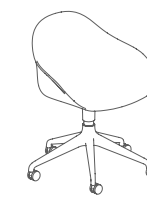

RUBYCH5S
Ruby Chair
with 5 Star base
mm
W 635 D 635 H 795 Seat 440
inch
W 25 D 25 H 31.5 Seat 17.5



RUBYCH5SL
Ruby Chair
with 5 Star base with Gas Lift
mm
W 635 D 635 H 795-895 Seat 440-540
inch
W 25 D 25 H 31.5-35 Seat 17.5-21.5

Base Finishes



4 Star Base
White / Black / Polished
Standard



4 Star Base
RAL Powder Coated
naughtone Colours



5 Star Base
White / Black / Polished
Standard



5 Star Base
RAL Powder Coated
naughtone Colours

Other Options



5 Star Base
Gas Lift mechanism

Seat Shell Colours



Lemon Yellow RAL 1012, Salmon Pink RAL 3022, Pastel Blue RAL 5024, Pale Green RAL 6021, Oyster RAL 1013, Black Grey RAL 7021, Stone Grey RAL 7030, Signal White RAL 9003

viv wood

Chair / Lounge / Barstool



About Viv Wood

As a simple and comfortable staple of the naughtone portfolio, the Viv Wood chair's slender shape combined with solid use of materials, is highlighted by its tight and skilful upholstery, making it a welcome addition to the home, meeting room or break out space.

Compliance

- SCS Indoor Advantage™ Gold Certificate
- FSC®certified products available upon request
- naughtone is FISP and ISO14001 certified
- Our chairs are designed to meet or exceed all EN performance requirements per BS EN 16139:2013
- Health Product Declaration (HPD) reports available

Sizes

All dimensions quoted are rounded to the nearest 5mm or nearest 1/2 inch



VIVCHWD
Viv Wood Chair
mm
W515 D 560 H780 Seat 450
inch
W20.5 D 22 H30.5 Seat 17.5



VIVCHSWD
Viv Wood Counter Height Stool
mm
W560 D 560 H910 Seat 660
inch
W22 D 22 H36 Seat 26



VIVBSWD
Viv Wood Barstool Chair
mm
W560 D 560 H1000 Seat 750
inch
W22 D 22 H39.5 Seat 29.5



VIVLOWD
Viv Wood Lounge Chair
mm
W595 D 650 H650 Seat 400
inch
W23.5 D 25.5 H25.5 Seat 16

Base Finishes



Solid Oak base
Standard

Solid Walnut base

viv

Chair / Lounge / Barstool

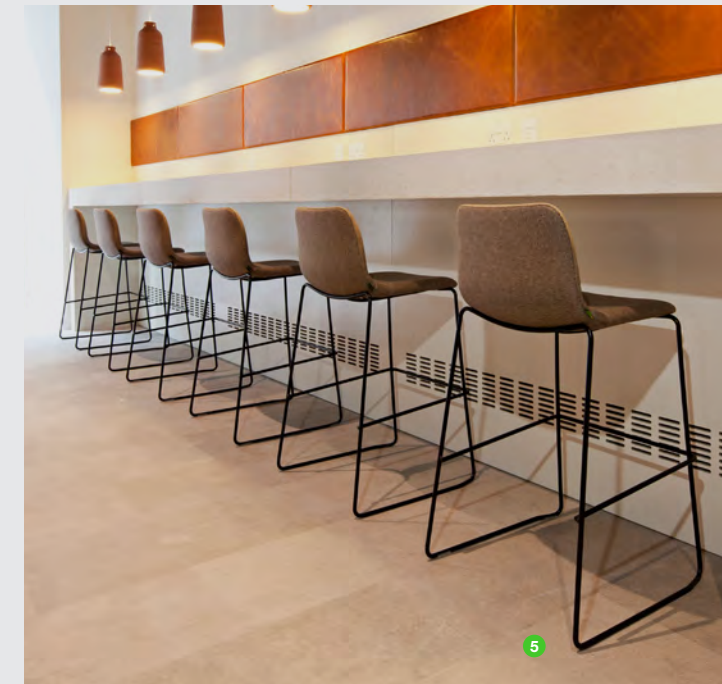

About Viv

As a simple and comfortable staple of the naughtone portfolio, the Viv chair's slender shape is highlighted by its tight and skilful upholstery, making it a welcome addition to the home, meeting room or break out space.

Viv stacks neatly on the ground and on a designated stacking trolley.

Compliance

- SCS Indoor Advantage™ Gold Certificate
- FSC®certified products available upon request
- naughtone is FISP and ISO14001 certified
- Our chairs are designed to meet or exceed all EN performance requirements per BS EN 16139:2013
- Health Product Declaration (HPD) reports available

Sizes

All dimensions quoted are rounded to the nearest 5mm or nearest 1/2 inch



VIVCHB4L
Viv Chair 4 Leg Base
mm
W560 D 550 H810 Seat 450
inch
W22 D21.5 H32 Seat 17.5



VIVCHSL
Viv Chair Sled Base
mm
W515 D 570 H825 Seat 450
inch
W20.5 D 22.5 H32.5 Seat 17.5



VIVCHBDL
Viv Chair Dowel Base
mm
W505 D 555 H810 Seat 450
inch
W20 D 22 H32 Seat 17.5



VIVCHSSL
Viv Counter Height Stool with Sled Base
mm
W565 D 545 H915 Seat 650
inch
W22 D21.5 H36 Seat 25.5



VIVBSSL
Viv Barstool with Sled Base
mm
W565 D 575 H1025 Seat 750
inch
W22 D22.5 H40.5 Seat 29.5



VIVLOSL
Viv Lounge Chair
mm
W595 D 815 H675 Seat 400
inch
W23.5 D 32 H26.5 Seat 15.5



VIVCHSB4L
Viv Counter Height Stool with 4 Leg Base
mm
W570 D 535 H955 Seat 650
inch
W22.5 D 21 H37.5 Seat 25.5



VIVBSB4L
Viv Barstool with 4 Leg Base
mm
W570 D 535 H1055 Seat 750
inch
W22.5 D 21 H41.5 Seat 29.5

Base Options



White / Black Powder Coated Base Standard



RAL Powder Coated Base naughtone Colours



Chrome Mild Steel Base



Dowel Base Oak / Walnut

Stacking Trolley Available for Chairs Only



STACKTRCOMP
Stacking Trolley Black
mm
W1010 D 595 H1690
inch
W 40 D 23.5 H 67

Stacking Quantities
Viv Chair Sled Base
On Stacking Trolley x 10

viv

4 Star / 5 Star



About Viv

As a simple and comfortable staple of the naughtone portfolio, the Viv chair's slender shape is highlighted by its tight and skilful upholstery, making it a welcome addition to the home, meeting room or break out space.

Compliance

- SCS Indoor Advantage™ Gold Certificate
- FSC®certified products available upon request
- naughtone is FISP and ISO14001 certified
- Our chairs are designed to meet or exceed all EN performance requirements per BS EN 16139:2013
- Health Product Declaration (HPD) reports available

Sizes All dimensions quoted are rounded to the nearest 5mm or nearest 1/2 inch

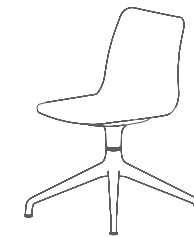

VIVCH4S
Viv 4 Star Base
mm
W500 D 530 H785 Seat 450
inch
W19.5 D 21 H 31 Seat 17.5

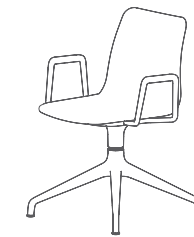

VIVACH4S
Viv Armchair 4 Star Base
mm
W500 D 530 H785 Seat 450
inch
W19.5 D 21 H 31 Seat 17.5

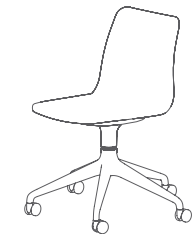

VIVCH5S
Viv Chair 5 Star Base
mm
W635 D 530 H785 Seat 450
inch
W25 D 21 H 31 Seat 17.5

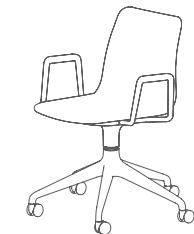

VIVACH5S
Viv Armchair 5 Star Base
mm
W635 D 530 H785 Seat 450
inch
W25 D 21 H 31 Seat 17.5

Base Finishes



4 Star Base
White / Black
Standard



4 Star Base
RAL Powder Coated
naughtone Colours



4 Star Base
Polished



5 Star Base
White / Black
Standard



5 Star Base
RAL Powder Coated
naughtone Colours



5 Star Base
Polished

Other Options



5 Star Base
Gas Lift mechanism

viv

Highback / Highback Lounge



About Viv Highback

Available as highback or highback lounge, Viv Highback has a simple, broadly appealing form with a premium feel. The comfortable and generous upholstery and tilt mechanism offers superior comfort and launches the Viv range into a new realm.

Compliance

- SCS Indoor Advantage™ Gold Certificate
- FSC®certified products available upon request
- naughtone is FISP and ISO14001 certified

Sizes All dimensions quoted are rounded to the nearest 5mm or nearest 1/2 inch



VIVHLO4S
Viv Highback Lounge Chair 4 Star Base
mm W 620 D 640 H 930 Seat 400
inch W 24.5 D 25 H 36.5 Seat 15.5



VIVHALO4S
Viv Highback Lounge Armchair 4 Star Base
mm W 620 D 640 H 930 Seat 400
inch W 24.5 D 25 H 36.5 Seat 15.5



VIVHCH4SL
Viv Highback Chair 4 Star Base with Gas Lift Mechanism
mm W 525 D 640 H 1025-1125 Seat 450-550
inch W 20.5 D 25 H 40-44 Seat 17.5-21.5



VIVHACH4SL
Viv Highback Armchair 4 Star Base with Gas Lift Mechanism
mm W 620 D 640 H 1025-1125 Seat 450-550
inch W 24.5 D 25 H 40-44 Seat 17.5-21.5



VIVHCH5SL
Viv Highback Chair 5 Star Base with Gas Lift Mechanism
mm W 635 D 640 H 1025-1125 Seat 450-550
inch W 25 D 25 H 40-44 Seat 17.5-21.5



VIVHACH5SL
Viv Highback Armchair 5 Star Base with Gas Lift Mechanism
mm W 635 D 640 H 1025-1125 Seat 450-550
inch W 25 D 25 H 40-44 Seat 17.5-21.5

Base Finishes



Lounge 4 Star Base White / Black Standard



Lounge 4 Star Base RAL Powder Coated naughtone Colours



Lounge 4 Star Base Polished

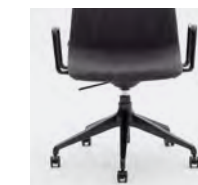

4 & 5 Star Base White / Black Standard



4 & 5 Star Base RAL Powder Coated naughtone Colours



4 & 5 Star Base Polished



bounce
Chair

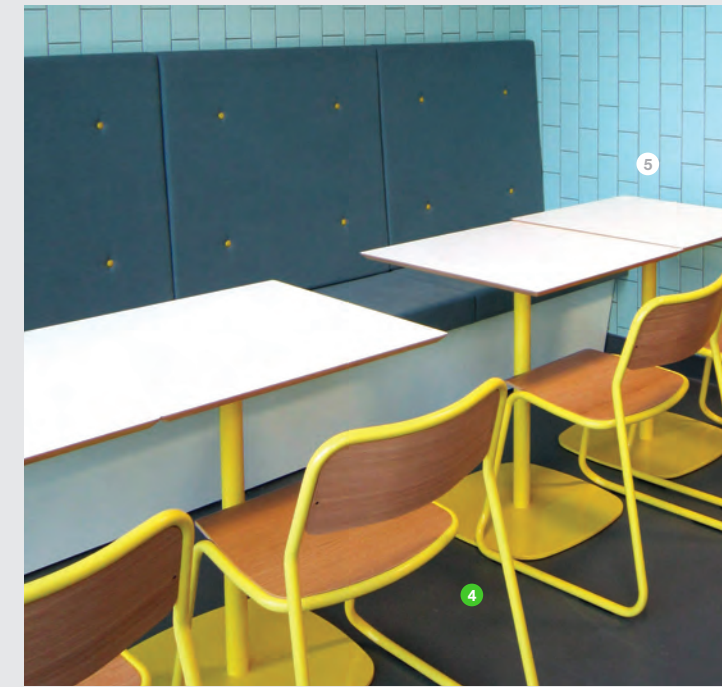

About Bounce

Called the Bounce chair due to the independent movement of the seat and back, this flex provides a comfort not usually associated with steel and plywood chairs. Bounce is robust, elegant, lightweight and stackable; it is seen widely used in educational and hospitality settings.

Bounce stacks 8 on the ground and 14 on dedicated stacking trolley.

Compliance

- SCS Indoor Advantage™ Gold Certificate
- FSC®certified products available upon request
- naughtone is FISP and ISO14001 certified
- Our chairs are designed to meet or exceed all EN performance requirements per BS EN 16139:2013

Sizes All dimensions quoted are rounded to the nearest 5mm or nearest 1/2 inch



NOBNN1
Bounce Chair
mm W 555 D 550 H 752 Seat 452
inch W 22 D 21.5 H 29.5 Seat 17.5



Stacking Quantity
On Ground x 8
On Stacking Trolley x 14

Stacking Trolley

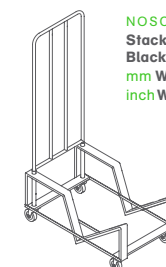

NOSCC100
Stacking Trolley
Black
mm W 1010 D 595 H 1690
inch W 40 D 23.5 H 67

Base Finishes



White Powder Coated Standard



Black Powder Coated Standard



RAL Powder Coated naughtone Colours

Seat and Back Finishes



Oak Standard



Walnut

always

Chair

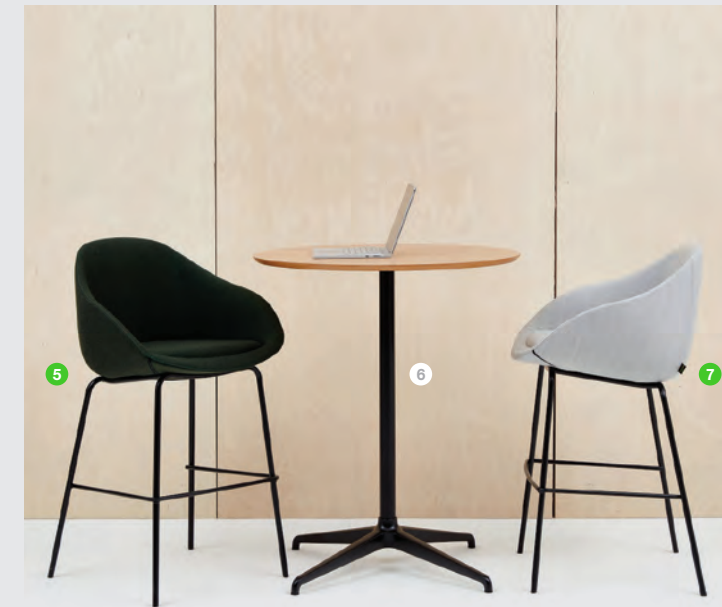

About Always

Named Always because there is always a place for this chair. This chair offers positive back support with a comfortable enclosed feeling. Always has been designed with an organic form that complements any interior and looks great from every angle.

Compliance

- SCS Indoor Advantage™ Gold Certificate
- FSC®certified products available upon request
- naughtone is FISP and ISO14001 certified
- Our chairs are designed to meet or exceed all EN performance requirements per BS EN 16139:2013
- Health Product Declaration (HPD) reports available

Sizes

All dimensions quoted are rounded to the nearest 5mm or nearest 1/2 inch



ALCHBST4
Always Chair
on 4 Leg Base
mm
W 625 D 595 H 780 Seat 470
inch
W 24.5 D 23.5 H 30.5 Seat 18



ALCHBSL
Always Chair
on Sled Base
mm
W 625 D 595 H 780 Seat 470
inch
W 24.5 D 23.5 H 30.5 Seat 18



ALCHBCL
Always Chair
on Cantilever Base
mm
W 625 D 610 H 780 Seat 470
inch
W 24.5 D 24 H 30.5 Seat 18



ALCHBWD
Always Chair
on Wooden Base
mm
W 625 D 595 H 780 Seat 470
inch
W 24.5 D 23.5 H 30.5 Seat 18



ALCHSST4
Always Counter Height Stool
on 4 Leg Base
mm
W 630 D 600 H 965 Seat 655
inch
W 25 D 23.5 H 38 Seat 26



ALBST4
Always Barstool
on 4 Leg Base
mm
W 630 D 600 H 1065 Seat 755
inch
W 25 D 23.5 H 42 Seat 30

Base Finishes



Steel 4 Leg Base
White / Black / Chrome

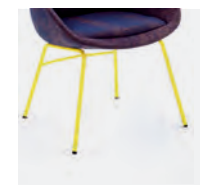

Steel 4 Leg Base
RAL Powder Coated
naughtone Colours



Solid Oak / Walnut Base



Sled Base
White / Black / Chrome



Sled Base
RAL Powder Coated
naughtone Colours



Cantilever
White / Black / Chrome



Cantilever
RAL Powder Coated
naughtone Colours

Other Options



Two Tone
Shell / Seatpad

naughtone RAL Colours



always

4 Star / 5 Star



2



1



3

4

About Always

Named Always because there is always a place for this chair. This chair offers positive back support with a comfortable enclosed feeling. Always has been designed with an organic form that complements any interior and looks great from every angle.

Compliance

- SCS Indoor Advantage™ Gold Certificate
- naughtone is FSC® certified
- naughtone is FISP and ISO14001 certified
- Our chairs are designed to meet or exceed all EN performance requirements per BS EN 16139:2013
- Health Product Declaration (HPD) reports available

Sizes

All dimensions quoted are rounded to the nearest 5mm or nearest 1/2 inch



Always Chair
with 4 Star base
mm
W625 D595 H780 Seat 470
inch
W24.5 D23.5 H30.5 Seat 18



Always Chair
with 5 Star base
mm
W635 D595 H780 Seat 470
inch
W25 D23.5 H30.5 Seat 18

Base Finishes



4 Star Base
White / Black
Standard



4 Star Base
RAL Powder Coated
naughtone Colours



4 Star Base
Polished



5 Star Base
White / Black
Standard

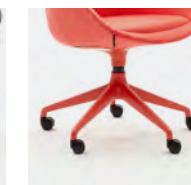

5 Star Base
RAL Powder Coated
naughtone Colours



5 Star Base
Polished

Other Options



5 Star Base Gas Lift
Optional

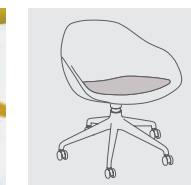

Two Tone
Shell / Seatpad

always lounge

Chair

About Always Lounge

An easy form for an easy chair; the Always Lounge hides its complexity well. A combination of shapes has created its relaxed form, allowing it to look great from all angles. The Always Lounge is completely customisable offering a wealth of upholstery options, working extremely well in hotels, the workplace, break out zones and public spaces.

Compliance

- SCS Indoor Advantage™ Gold Certificate
- FSC®certified products available upon request
- naughtone is FISP and ISO14001 certified
- Our chairs are designed to meet or exceed all EN performance requirements per BS EN 16139:2013
- Health Product Declaration (HPD) reports available



Sizes

All dimensions quoted are rounded to the nearest 5mm or nearest 1/2 inch



ALLOBST4
Always Lounge
4 Leg Base
mm W 790 D 800 H 930 Seat 420
inch W 31 D 31.5 H 36.5 Seat 16.5



ALLOBSL
Always Lounge
Sled Base
mm W 790 D 800 H 930 Seat 420
inch W 31 D 31.5 H 36.5 Seat 16.5



ALLOB4S
Always Lounge
4 Star Base
mm W 790 D 800 H 930 Seat 420
inch W 31 D 31.5 H 36.5 Seat 16.5



ALLOBWD
Always Lounge
on Wooden Base
mm W 790 D 800 H 930 Seat 420
inch W 31 D 31.5 H 36.5 Seat 16.5



ALLOBRK
Always Lounge
Rocker
mm W 790 D 815 H 930 Seat 420
inch W 31 D 32 H 36.5 Seat 16.5

Base Finishes



Steel 4 Leg
White / Black / Chrome



Steel 4 Leg
RAL Powder Coated
naughtone colours



Solid Oak / Walnut Base



Sled Base
White / Black / Chrome



Sled Base
RAL Powder Coated
naughtone Colours



Wooden Rocker Base



4 Star Base
Black / White / Polished



4 Star Base
RAL Powder Coated
naughtone Colours

Other Options



Two Tone
Shell / Seatpad

naughtone RAL Colours





fiji
Chair / Sofa

1

2

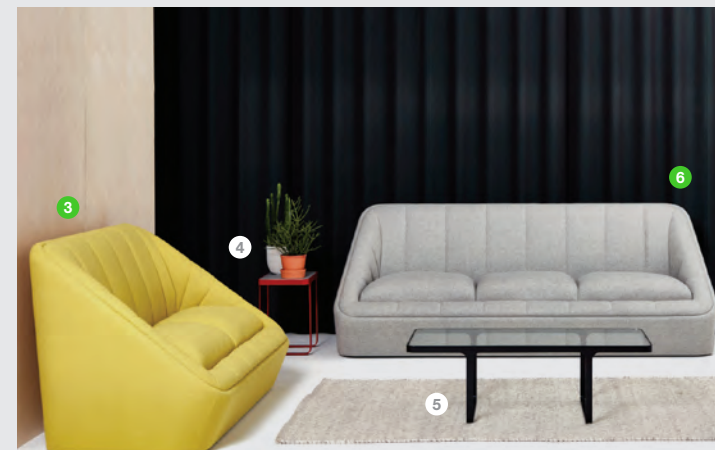

About Fiji

As naughtone's most luxuriously upholstered lounge chair and sofa, the Fiji range offers a significantly different aesthetic to other naughtone lounge chairs, as the plush upholstery provides a welcoming cocoon-esque retreat. The hidden swivel on Fiji chair makes it ideal for a multitude of situations.

Compliance

- SCS Indoor Advantage™ Gold Certificate
- FSC®certified products available upon request
- naughtone is FISP and ISO14001 certified
- Our seating is designed to meet or exceed all EN performance requirements per BS EN 16139:2013

Sizes All dimensions quoted are rounded to the nearest 5mm or nearest 1/2 inch

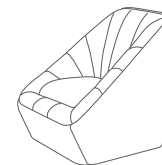

FIJICH
Fiji Chair
mm W 850 D 865 H 885 Seat 470
inch W 33.5 D 34 H 35 Seat 18.5

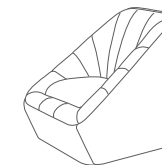

FIJICHBSW
Fiji Chair with Swivel
mm W 850 D 865 H 885 Seat 470
inch W 33.5 D 34 H 35 Seat 18.5



FIJI2SF
Fiji 2 seat sofa
mm W 1650 D 865 H 885 Seat 470
inch W 65 D 34 H 35 Seat 18.5

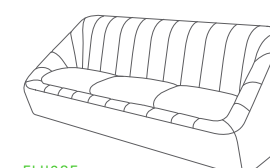

FIJI3SF
Fiji 3 seat sofa
mm W 2250 D 865 H 885 Seat 470
inch W 88.5 D 34 H 35 Seat 18.5

Other Options

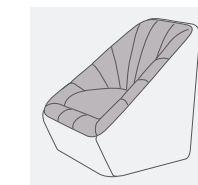

Two Tone
Outer / Inner and Seat Cushion

hush low

Chair



About Hush Low

Hush Low is a compact lounge chair designed with a slender shape and positive sit, making it the ideal retreat for working, reading or taking some time out. Being completely customisable, Hush Low looks fantastic in educational spaces, break out zones and reception lounges.

Compliance

- SCS Indoor Advantage™ Gold Certificate
- FSC® certified products available upon request
- naughtone is FISP and ISO14001 certified
- Our chairs are designed to meet or exceed all EN performance requirements per BS EN 16139:2013
- Health Product Declaration (HPD) reports available

Sizes

All dimensions quoted are rounded to the nearest 5mm or nearest 1/2 inch

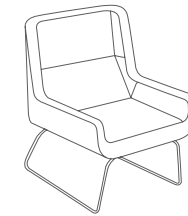

HULOBSL
Hush Low Chair
with Sled Base
mm
W720 D760 H880 Seat 430
inch
W28.5 D30 H34.5 Seat 17



HULOB4S
Hush Low Chair 4 Star Base
with Standard Glides
mm
W720 D760 H880 Seat 430
inch
W28.5 D30 H34.5 Seat 17

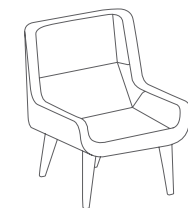

HULOBWD
Hush Low Chair
with Wooden Legs
mm
W720 D760 H880 Seat 430
inch
W28.5 D30 H34.5 Seat 17

Base Finishes



Sled Base
White / Black
Standard

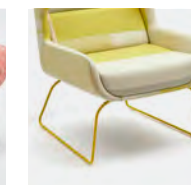

Sled Base
RAL Powder Coated
naughtone Colours



Sled Base
Chrome



4 Star Base
Black / White / Polished

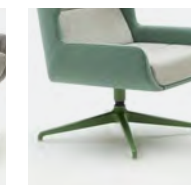

4 Star Base
RAL Powder Coated
naughtone Colours



Turned Solid
Oak Legs



Turned Solid
Walnut Legs

Other Options

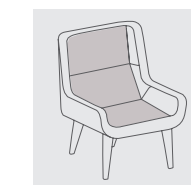

Two Tone
Outer / Inner

hush low

Sofa



About Hush Low Sofa

Hush Low Sofa is a compact sofa with simple, broad appeal. Being designed with an upright, positive seating position allows Hush Low Sofa to be ideally suited for reception lounges and public spaces.

Compliance

- SCS Indoor Advantage™ Gold Certificate
- FSC®certified products available upon request
- naughtone is FISP and ISO14001 certified
- Our chairs are designed to meet or exceed all EN performance requirements per BS EN 16139:2013

Sizes

All dimensions quoted are rounded to the nearest 5mm or nearest 1/2 inch

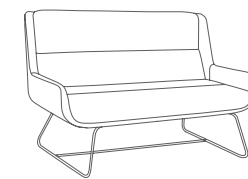

HLO2SFBSL
Hush Low 2 Seat Sofa
with Sled Base
mm
W 1350 D 760 H 880 Seat 430
inch
W 53 D 30 H 34.5 Seat 17

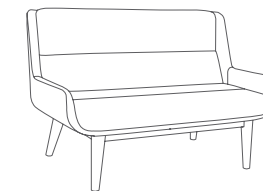

HLO2SFBWD
Hush Low 2 Seat Sofa
with Wooden Base
mm
W 1350 D 760 H 880 Seat 430
inch
W 53 D 30 H 34.5 Seat 17

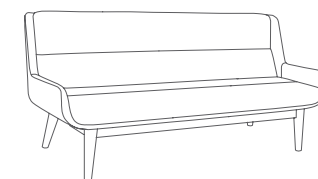

HLO3SFBWD
Hush Low 3 Seat Sofa
with Wooden Base
mm
W 2000 D 760 H 880 Seat 430
inch
W 79 D 30 H 34.5 Seat 17

Base Finishes



Sled Base
White / Black
Standard



Sled Base
RAL Powder Coated
naughtone Colours



Sled Base
Chrome



Turned Solid Oak
or Walnut Legs



Turned Solid Oak
or Walnut Legs

Other Options

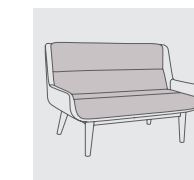

Two Tone
Outer / Inner

hush

Chair



1



2



3



4

5

About Hush

Hush takes inspiration from the past but responds to contemporary demands. The unmistakable wing-back form offers a welcoming familiarity and sanctuary, making it an ideal retreat for working, relaxing or having private conversations in.

Compliance

- SCS Indoor Advantage™ Gold Certificate
- FSC® certified products available upon request
- naughtone is FISP and ISO14001 certified
- Our chairs are designed to meet or exceed all EN performance requirements per BS EN 16139:2013
- Health Product Declaration (HPD) reports available

Sizes

All dimensions quoted are rounded to the nearest 5mm or nearest 1/2 inch



HUSHBSL
Hush Chair
with Sled Base
mm
W 720 D 815 H 1160 Seat 430
inch
W 28.5 D 32 H 45.5 Seat 17



HUSHB4S
Hush Chair 4 Star Base
with Standard Glides
mm
W 720 D 815 H 1160 Seat 430
inch
W 28.5 D 32 H 45.5 Seat 17

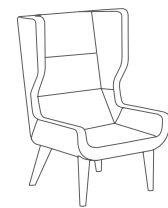

HUSHBWD
Hush Chair
with Wooden Legs
mm
W 720 D 815 H 1160 Seat 430
inch
W 28.5 D 32 H 45.5 Seat 17

Base Finishes



Sled Base
White / Black
Standard

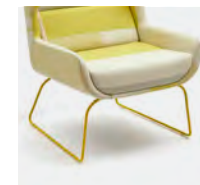

Sled Base
RAL Powder Coated
naughtone Colours



Sled Base
Chrome



4 Star Base
Black / White / Polished

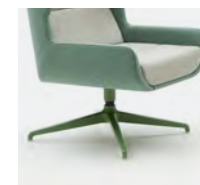

4 Star Base
RAL Powder Coated
naughtone Colours



Turned Solid
Oak Legs



Turned Solid
Walnut Legs

Other Options

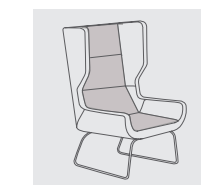

Two Tone
Outer / Inner

naughtone RAL Colours



hush

Sofa



1

2



3

4

5

About Hush Sofa

The Hush Sofa makes perfect sense of the distinctive Hush profile, taking on its own elegant characteristic whilst expanding on the acoustic benefits. The Hush Sofa is ideally suited for reception lounges and public spaces.

Compliance

- SCS Indoor Advantage™ Gold Certificate
- FSC® certified products available upon request
- naughtone is FISP and ISO14001 certified
- Our chairs are designed to meet or exceed all EN performance requirements per BS EN 16139:2013

Sizes

All dimensions quoted are rounded to the nearest 5mm or nearest 1/2 inch

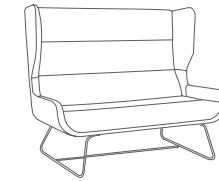

HSH2SFBSL
Hush 2 Seat Sofa
with Sled Base
mm
W 1350 D 815 H 1160 Seat 430
inch
W 53 D 32 H 45.5 Seat 17

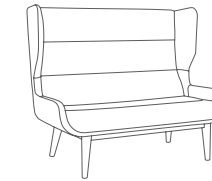

HSH2SFBWD
Hush 2 Seat Sofa
with Wooden Base
mm
W 1350 D 815 H 1160 Seat 430
inch
W 53 D 32 H 45.5 Seat 17

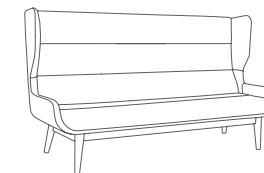

HSH3SFBWD
Hush 3 Seat Sofa
with Wooden Base
mm
W 2000 D 815 H 1160 Seat 430
inch
W 79 D 32 H 45.5 Seat 17

Base Finishes



Sled Base
White / Black
Standard

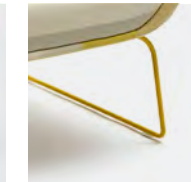

Sled Base
RAL Powder Coated
naughtone Colours



Sled Base
Chrome



Turned Solid Oak
or Walnut Legs

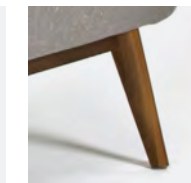

Turned Solid Oak
or Walnut Legs

Other Options

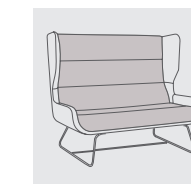

Two Tone
Outer / Inner

cloud quilt

Armchair and Sofa



About Cloud

The Cloud seating range is designed to be inviting and comfortable without consuming masses of space. The tactile and fully upholstered surround provides a further element of luxury whilst offering a visual and acoustic haven for individual or group work.

Available in UK, Europe and Asia only

Compliance

- SCS Indoor Advantage™ Gold Certificate
- FSC® certified products available upon request
- naughtone is FISP and ISO14001 certified
- Our seating is designed to meet or exceed all EN performance requirements per BS EN 16139:2013



Sizes

All dimensions quoted are rounded to the nearest 5mm or nearest 1/2 inch

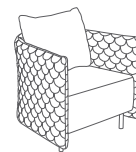

CLOG1
Cloud Quilt Armchair with Low Back
mm W 800 D 750 H 650 Seat 400
inch W 31.5 D 29.5 H 25.5 Seat 15.5

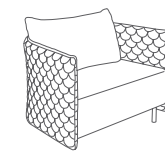

CLOG15L
Cloud Quilt 1.5 Seat Sofa with Low Back
mm W 1100 D 750 H 650 Seat 400
inch W 43.5 D 29.5 H 25.5 Seat 15.5

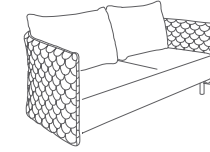

CLOG2L
Cloud Quilt 2 Seat Sofa with Low Back
mm W 1600 D 750 H 650 Seat 400
inch W 63 D 29.5 H 25.5 Seat 15.5

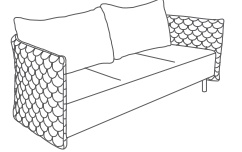

CLOG3L
Cloud Quilt 3 Seat Sofa with Low Back
mm W 2100 D 750 H 650 Seat 400
inch W 82.5 D 29.5 H 25.5 Seat 15.5

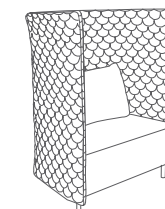

CLOG15H
Cloud Quilt 1.5 Seat Sofa with High Back
mm W 1100 D 750 H 1300 Seat 400
inch W 43.5 D 29.5 H 51 Seat 15.5

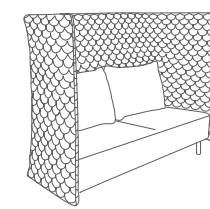

CLOG2H
Cloud Quilt 2 Seat Sofa with High Back
mm W 1600 D 750 H 1300 Seat 400
inch W 63 D 29.5 H 51 Seat 15.5

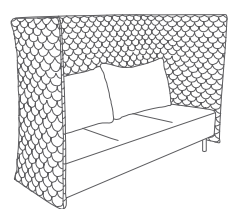

CLOG3H
Cloud Quilt 3 Seat Sofa with High Back
mm W 2100 D 750 H 1300 Seat 400
inch W 82.5 D 29.5 H 51 Seat 15.5

Base Options



Black Powder Coated Steel Straight Legs Standard



Turned Solid Oak or Walnut Legs

Other Options

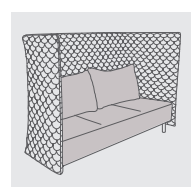

Two Tone Outer / Seat and Cushions



cloud plain

Armchair and Sofa



About Cloud

The Cloud seating range is designed to be inviting and comfortable without consuming masses of space. The tactile and fully upholstered surround provides a further element of luxury whilst offering a visual and acoustic haven for individual or group work.

Compliance

- SCS Indoor Advantage™ Gold Certificate
- FSC®certified products available upon request
- naughtone is FISP and ISO14001 certified
- Our seating is designed to meet or exceed all EN performance requirements per BS EN 16139:2013

Sizes

All dimensions quoted are rounded to the nearest 5mm or nearest 1/2 inch



CLOP1
Cloud Plain Armchair with Low Back
mm W 800 D 750 H 650 Seat 400
inch W 31.5 D 29.5 H 25.5 Seat 15.5

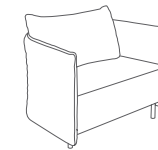

CLOP15L
Cloud Plain 1.5 Seat Sofa with Low Back
mm W 1100 D 750 H 650 Seat 400
inch W 43.5 D 29.5 H 25.5 Seat 15.5

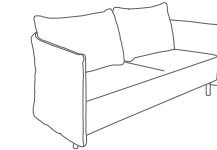

CLOP2L
Cloud Plain 2 Seat Sofa with Low Back
mm W 1600 D 750 H 650 Seat 400
inch W 63 D 29.5 H 25.5 Seat 15.5

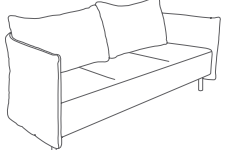

CLOP3L
Cloud Plain 3 Seat Sofa with Low Back
mm W 2100 D 750 H 650 Seat 400
inch W 82.5 D 29.5 H 25.5 Seat 15.5

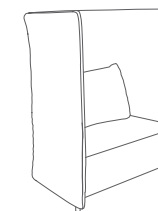

CLOP15H
Cloud Plain 1.5 Seat Sofa with High Back
mm W 1100 D 750 H 1300 Seat 400
inch W 43.5 D 29.5 H 51 Seat 15.5

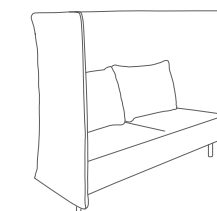

CLOP2H
Cloud Plain 2 Seat Sofa with High Back
mm W 1600 D 750 H 1300 Seat 400
inch W 63 D 29.5 H 51 Seat 15.5

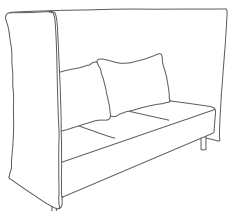

CLOP3H
Cloud Plain 3 Seat Sofa with High Back
mm W 2100 D 750 H 1300 Seat 400
inch W 82.5 D 29.5 H 51 Seat 15.5

Base Options

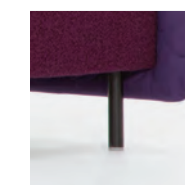

Black Powder Coated Steel Straight Legs Standard



Turned Solid Oak or Walnut Legs

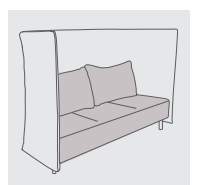

Two Tone Outer / Seat and Cushions

Other Options

cloud booth

Plain / Quilted

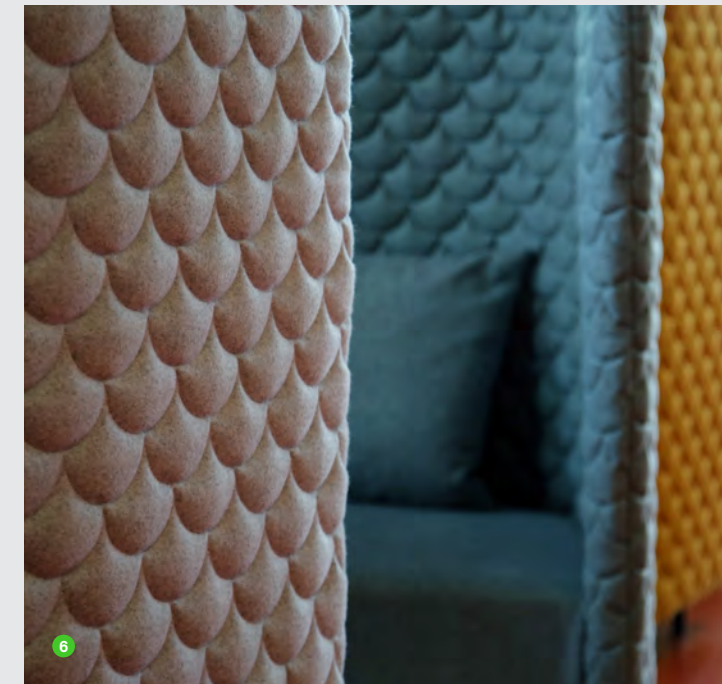

About Cloud

The Cloud seating range is designed to be inviting and comfortable without consuming masses of space. The tactile and fully upholstered surround provides a further element of luxury whilst offering a visual and acoustic haven for individual or group work.

Cloud Quilt available only in UK, Europe and Asia

Compliance

- SCS Indoor Advantage™ Gold Certificate
- FSC® certified products available upon request
- naughtone is FISP and ISO14001 certified
- Our booths are designed to meet or exceed all EN performance requirements per BS EN 16139:2013

Sizes

All dimensions quoted are rounded to the nearest 5mm or nearest 1/2 inch

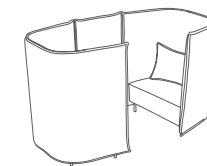

CLOBP15
Cloud Plain 1.5 Seat Booth with Privacy Panel
mm W 1100 D 2200 H 1300 Seat 400
inch W 43.5 D 86.5 H 51 Seat 15.5

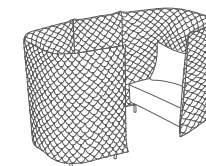

CLOBQ15
Cloud Quilt 1.5 Seat Booth with Privacy Panel
mm W 1100 D 2200 H 1300 Seat 400
inch W 43.5 D 86.5 H 51 Seat 15.5

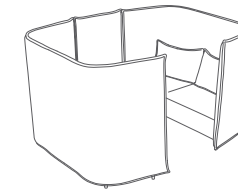

CLOBP2
Cloud Plain 2 Seat Booth with Privacy Panel
mm W 1600 D 2200 H 1300 Seat 400
inch W 63 D 86.5 H 51 Seat 15.5

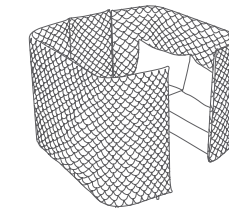

CLOBQ2
Cloud Quilt 2 Seat Booth with Privacy Panel
mm W 1600 D 2200 H 1300 Seat 400
inch W 63 D 86.5 H 51 Seat 15.5

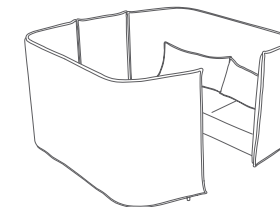

CLOBP3
Cloud Plain 3 Seat Booth with Privacy Panel
mm W 2100 D 2200 H 1300 Seat 400
inch W 82.5 D 86.5 H 51 Seat 15.5

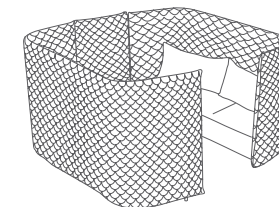

CLOBQ3
Cloud Quilt 3 Seat Booth with Privacy Panel
mm W 2100 D 2200 H 1300 Seat 400
inch W 82.5 D 86.5 H 51 Seat 15.5

Base Options



Black Powder Coated Steel Straight Legs Standard

Turned Solid Oak or Walnut Legs

Other Options

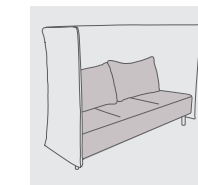

Two Tone Outer / Seat and Cushions

cloud desk

Plain / Quilted



About Cloud Desk

Cloud Desk is a fully upholstered booth that is a truly satisfying place to sit and concentrate. As a visual and acoustic haven, Cloud Desk offers users a comfortable and private space to work independently.



Compliance

- SCS Indoor Advantage™ Gold Certificate
- FSC® certified products available upon request
- naughtone is FISP and ISO14001 certified
- Our desk furniture is designed to meet or exceed all EN performance requirements per BS EN 527-2:2016

Sizes

All dimensions quoted are rounded to the nearest 5mm or nearest 1/2 inch

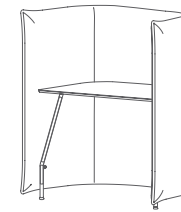

CLODP15H
Cloud 1.5 Desk
with High Plain Back
mm
W 1100 D 750 H 1300
Table height 750
inch
W 43.5 D 29.5 H 51
Table height 29.5

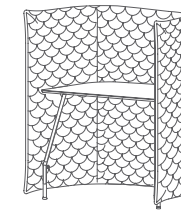

CLODQ15H
Cloud 1.5 Desk
with High Quilted Back
mm
W 1100 D 750 H 1300
Table height 750
inch
W 43.5 D 29.5 H 51
Table height 29.5

Top Options



White / Black MFMDF
with reverse chamfer,
polished MDF edge



Oak Veneer
with reverse chamfer,
polished MDF edge



Walnut Veneer
with reverse chamfer,
polished MDF edge



Forbo Lino
with reverse chamfer edge
8 colours available

Leg Finishes

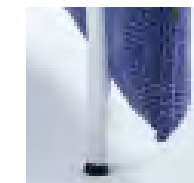

White Powder Coated
Standard



Black Powder Coated
Standard

pullman

Chair



About Pullman Chair

The Pullman chair is part of the wider Pullman range of high back seating products. The Pullman range functions as an attractive private retreat or group collaboration space, on an economical footprint.

Pullman chair is a unique single user privacy seat that acts as an acoustic haven for individual working or retreating. When specified with an upholstered swiveling plinth, users are able to retreat away from disruption, even further, allowing private conversations, work or relaxation to remain private.

The unique integrated tablet provides an opportunity for users to work within the space for longer periods of time, maintaining comfort.

Compliance

- SCS Indoor Advantage™ Gold Certificate
- FSC® certified products available upon request
- naughtone is FISP and ISO14001 certified
- Our seating is designed to meet or exceed all EN performance requirements per BS EN 16139:2013

Sizes

All dimensions quoted are rounded to the nearest 5mm or nearest 1/2 inch

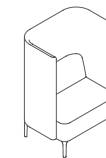

PUL15H
Pullman Chair with Legs
mm W900 D675 H1300 Seat 450
inch W35.5 D26.5 H51 Seat 18

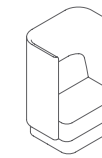

PUL15HPL
Pullman Chair with Upholstered Plinth
mm W900 D675 H1300 Seat 450
inch W35.5 D26.5 H51 Seat 18

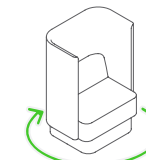

PUL15HSW
Pullman Chair with Upholstered Plinth
mm W900 D675 H1300 Seat 450
inch W35.5 D26.5 H51 Seat 18

Table Top Options



White / Black MFMD
with reverse chamfer,
polished MDF edge



Oak Veneer
with reverse chamfer,
polished MDF edge



Walnut Veneer
with reverse chamfer,
polished MDF edge

Accessories



Scatter Cushion



Power and Data

Tablet Arm & Power

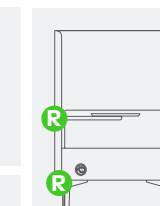

Chair
Right hand side only

Leg Finishes

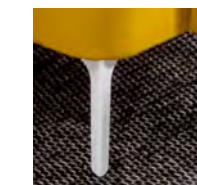

White / Black Steel Legs
Standard



RAL Powder Coated Legs
naughtone Colours



Solid Oak Legs



Solid Walnut Legs

Other Options

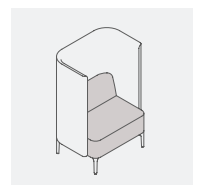

Two Tone Sofa
Outer screen / seat & backrest

pullman

Sofa



About Pullman Sofa

The Pullman sofa is part of the wider Pullman range of high back seating products. The Pullman range functions as an attractive private retreat or group collaboration space, on an economical footprint.

Pullman Sofa is a compact high back sofa range; the high back creates an ideal retreat for individuals to relax in, take private phone calls within or to have a chat with a colleague in an informal environment.

The addition of the integrated tablet arms transforms the sofa into an option for private or collaborative working.

Compliance

- SCS Indoor Advantage™ Gold Certificate
- FSC®certified products available upon request
- naughtone is FISP and ISO14001 certified
- Our seating is designed to meet or exceed all EN performance requirements per BS EN 16139:2013

Sizes

All dimensions quoted are rounded to the nearest 5mm or nearest 1/2 inch

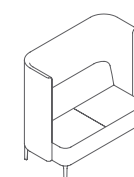

PUL2H
Pullman 2 Seat Sofa with Legs
mm W 1300 D 675 H 1300 Seat 450
inch W 51 D 26.5 H 51 Seat 18

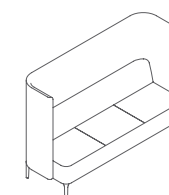

PUL3H
Pullman 3 Seat Sofa with Legs
mm W 1900 D 675 H 1300 Seat 450
inch W 75 D 26.5 H 51 Seat 18

Table Top Options



White / Black MFMDF
with reverse chamfer,
polished MDF edge

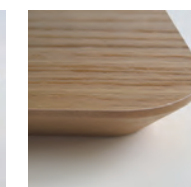

Oak Veneer
with reverse chamfer,
polished MDF edge

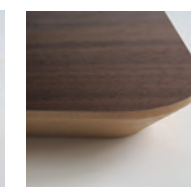

Walnut Veneer
with reverse chamfer,
polished MDF edge

Leg Finishes

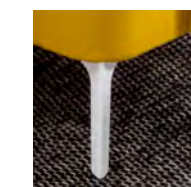

White / Black Steel Legs
Standard

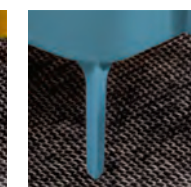

RAL Powder Coated Legs
naughtone Colours



Two Tone Sofa
Outer screen / seat & backrest



Solid Oak Legs



Solid Walnut Legs

Accessories



Scatter Cushion



Power and Data

Tablet Arms & Power

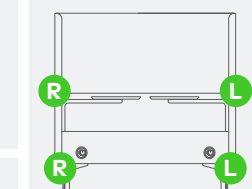

2 & 3 Seat Sofa
Left hand side
Right hand side
Left & right hand side

naughtone RAL Colours



pullman

Booth



About Pullman

Taking its name from the old train carriages, Pullman is a luxurious and private collaboration space developed with AV integration in mind. Pullman is an acoustic haven and has discrete cable management built in, making it ideal for breakout, small meetings or individual working.

Compliance

- SCS Indoor Advantage™ Gold Certificate
- FSC®certified products available upon request
- naughtone is FISP and ISO14001 certified
- Our seating is designed to meet or exceed all EN performance requirements per BS EN 16139:2013

Sizes

All dimensions quoted are rounded to the nearest 5mm or nearest 1/2 inch

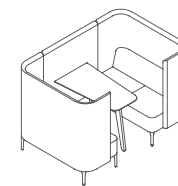

PULB2H
Pullman 2 Seat Booth
mm W 1950 D 1300 H 1300 Seat 450
Inch W 77 D 47 H 51 Seat 18

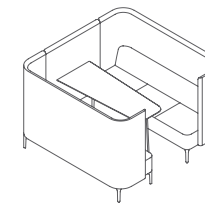

PULB3H
Pullman 3 Seat Booth
mm W 1950 D 1900 H 1300 Seat 450
Inch W 77 D 75 H 51 Seat 18

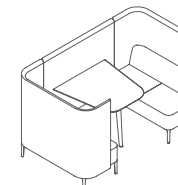

PULBW2H
Pullman 2 Seat Booth Wide
mm W 2250 D 1300 H 1300 Seat 450
Inch W 88.5 D 51 H 51 Seat 18

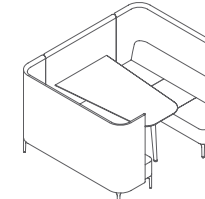

PULBW3H
Pullman 3 Seat Booth Wide
mm W 2250 D 1900 H 1300 Seat 450
Inch W 88.5 D 75 H 51 Seat 18

Table Top Options



White / Black MFMDf edge banded



White / Black MFMDf with reverse chamfer, polished MDF edge



Forbo Lino with reverse chamfer edge 8 colours available



Oak Veneer with reverse chamfer, polished MDF edge



Walnut Veneer with reverse chamfer, polished MDF edge

Base Finishes

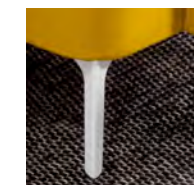

White / Black Steel Legs Standard

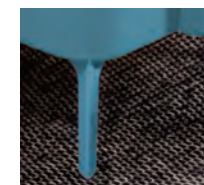

RAL Powder Coated Legs naughtone Colours

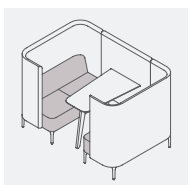

Two Tone Seat / All Sides



Solid Oak Legs



Solid Walnut Legs

Accessories



Panda Power and Data



TV Mounting Bracket to fit 13" to 27" screen (TV not included)



Magnetic White Board accessory supplied with magnets

naughtone RAL Colours





hue

Seating

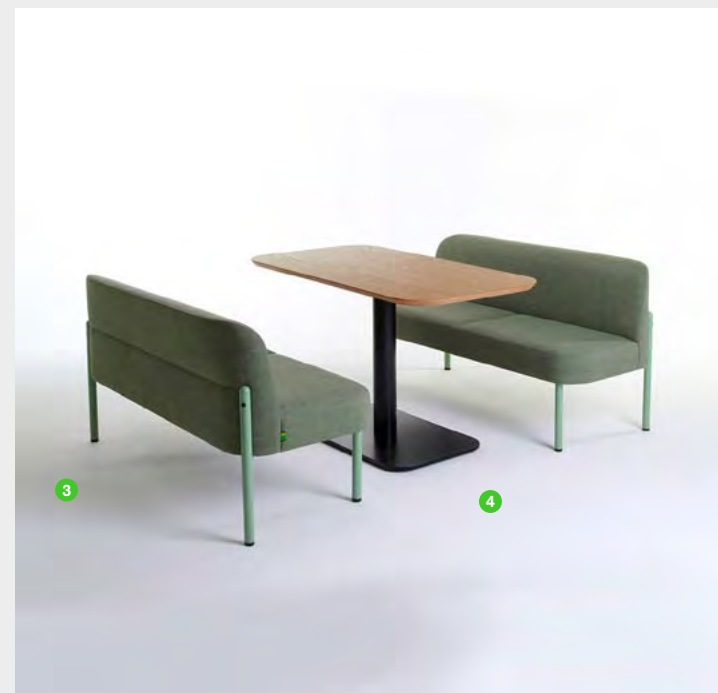

About Hue

Hue is designed for dividing, creating and utilising awkward space whilst encouraging collaboration at a higher posture. As a luxurious retreat for group or individual work, Hue is perfect for use in narrow spaces, and is ideally suited for pre and post meeting situations.

Part of the wider Hue range, Hue sofa has a fully upholstered seat with a steel frame that combine to make an attractive and comfortable sofa range available as standard or bar height.

Use Hue sofa with Hue table to create touch down points in awkward spaces.

Compliance

- SCS Indoor Advantage™ Gold Certificate
- FSC®certified products available upon request
- naughtone is FISP and ISO14001 certified

Sizes

All dimensions quoted are rounded to the nearest 5mm or nearest 1/2 inch

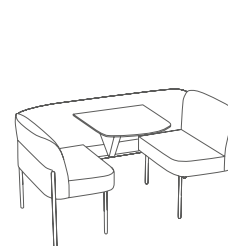

HUESST
Hue with Steel Legs
mm W 1870 D 940 H 750 Seat 450
inch W 73.5 D 37 H 29.5 Seat 18

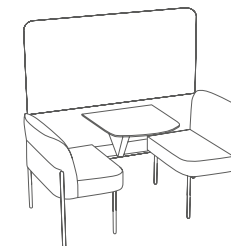

HUESST
Hue with Screen and Steel Legs
mm W 1870 D 900 H 1495 Seat 450
inch W 73.5 D 35.5 H 59 Seat 18

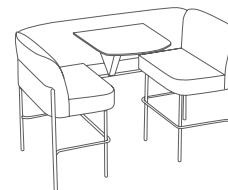

HUEBHST
Hue Bar Height with Steel Legs
mm W 1870 D 940 H 1050 Seat 750
inch W 73.5 D 37 H 41.5 Seat 29.5

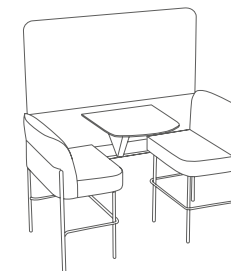

HUEBHST
Hue Bar Height with Screen and Steel Legs
mm W 1870 D 900 H 1795 Seat 750
inch W 73.5 D 35.5 H 70.5 Seat 29.5



HUE2NAST
Hue Sofa with Steel Legs
mm W 1400 D 630 H 750 Seat 450
inch W 55 D 25 H 29.5 Seat 17.5

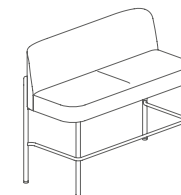

HUEBH2NAST
Hue Bar Height Sofa with Steel Legs
mm W 1400 D 630 H 1050 Seat 750
inch W 55 D 25 H 41.5 Seat 29.5

Table Top Options



White / Black MFMD
with reverse chamfer,
polished MDF edge



Oak Veneer
with reverse chamfer,
polished MDF edge



Walnut Veneer
with reverse chamfer,
polished MDF edge

Leg Finishes



White / Black Steel
Legs
Standard



RAL Powder Coated
Legs
naughtone Colours

Other Options

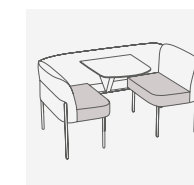

Two Tone
Back and Screen /
Seat Cushion

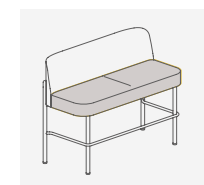

Two Tone
Back and Screen /
Seat Cushion

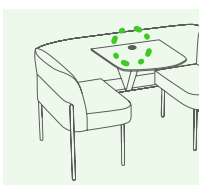

Power unit located centrally,
next to screen





hue

Seating and Table

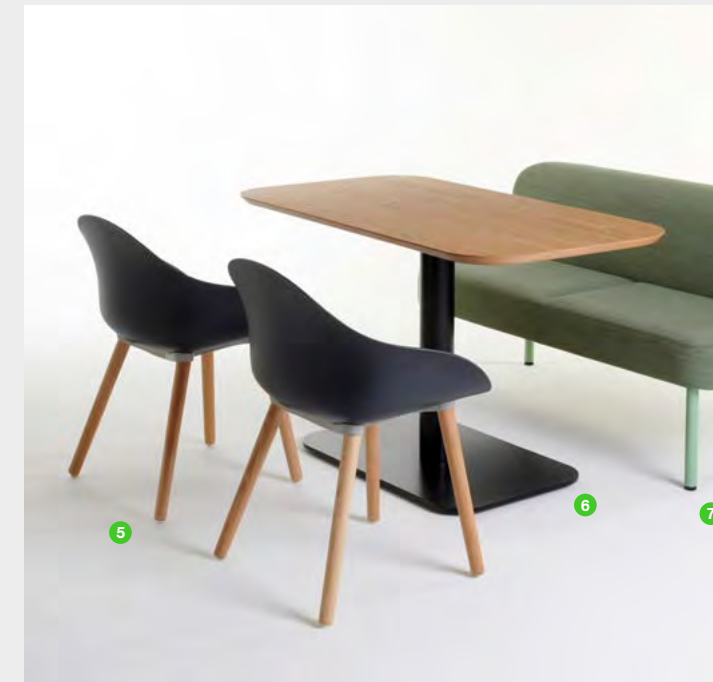

About Hue Table

With a pared-down elongated design and robust construction, the Hue table is perfectly suited to working or collaborating at a standard or bar height. The minimalistic soft rectangular shaped base and hollow stem allows for maximum leg space and can be fitted with power and data.

Use Hue sofa with Hue table to create touch down points in awkward spaces.

Compliance

- SCS Indoor Advantage™ Gold Certificate
- FSC®certified products available upon request
- naughtone is FISP and ISO14001 certified

Sizes

All dimensions quoted are rounded to the nearest 5mm or nearest 1/2 inch

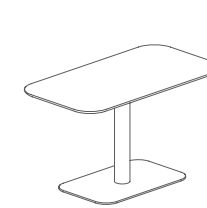

HUET130X70
Hue Rectangular Table
mm W1300 D700 H750
inch W51 D27.5 H29.5

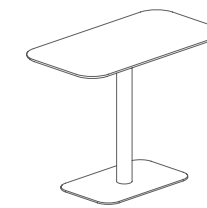

HUEBHT130X70
Hue Rectangular Bar Height Table
mm W1300 D700 H1000
inch W51 D27.5 H39.5

Base Finishes



White Powder Coated Base and Stem
Standard



Black Powder Coated Base and Stem
Standard



RAL Powder Coated Base and Stem
naughtone Colours

Top Options



White / Black MFMDF
with reverse chamfer,
polished MDF edge



Oak Veneer
with reverse chamfer,
polished MDF edge



Walnut Veneer
with reverse chamfer,
polished MDF edge

Power and Data

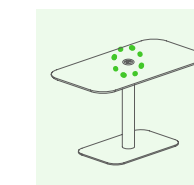

Power unit located centrally.



rhyme

Modular Seating



About Rhyme

Rhyme is a modular seating system that transforms the landscape within an atrium, creating ad-hoc zones or being used as an island, making it a striking choice for educational spaces, shopping centres or large public areas. Each of the nine pieces within the range are fully upholstered, with the same trapezoid footprint to allow for easy planning.

Compliance

- SCS Indoor Advantage™ Gold Certificate
- FSC® certified products available upon request
- naughtone is FISP and ISO14001 certified
- Our seating is designed to meet or exceed all EN performance requirements per BS EN 16139:2013
- Health Product Declaration (HPD) reports available

Sizes

All dimensions quoted are rounded to the nearest 5mm or nearest 1/2 inch

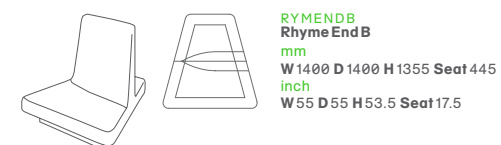
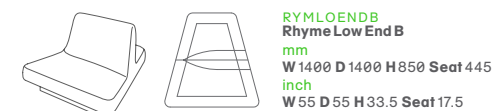
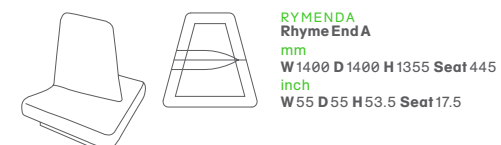
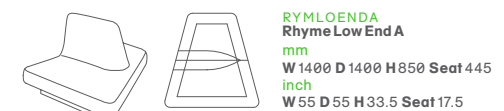
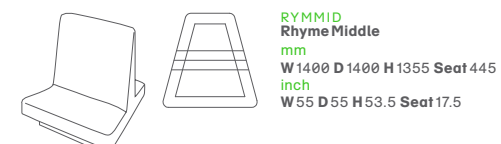
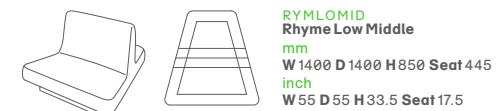
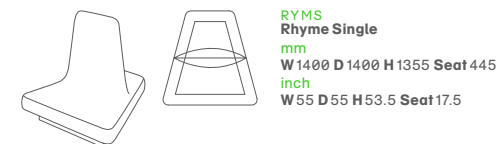
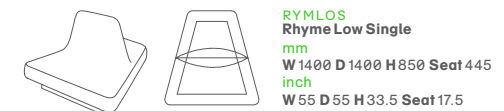
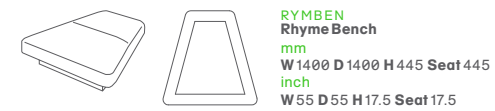

Example
Rhyme configuration
X2 RYMENDB
X2 RYMBEN

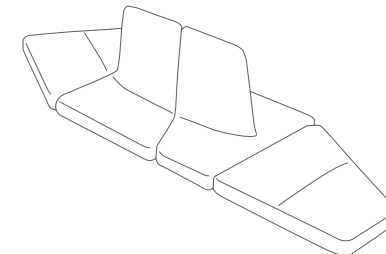

Plinth Finishes

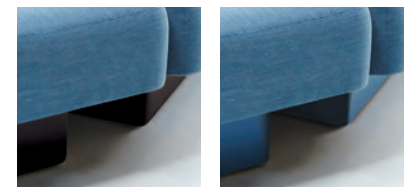

Black / White Powder Coated Plinth Standard

RAL Powder Coated Plinth naughtone Colours

Other Options



Plinth Infill Panel to match Plinth colour

Power and Data

Power unit is installed in the centre of the plinth

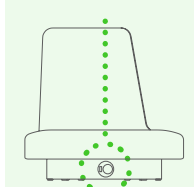

Power and Data options available Please specify

- S 1x power small side
- L 1x power large side
- B 2x power both sides



busby

Chair

①

②



About Busby

Busby is a modern cocoon for everyday situations, working particularly well as a haven for employees in open plan work spaces, or for users to take private phone calls within a reception lounge.

Compliance

- SCS Indoor Advantage™ Gold Certificate
- FSC® certified products available upon request
- naughtone is FISP and ISO14001 certified
- Our chairs are designed to meet or exceed all EN performance requirements per BS EN 16139:2013

Sizes

All dimensions quoted are rounded to the nearest 5mm or nearest 1/2 inch



NOBSN11
Busby Chair Left Hand with Cushions
 mm
 W850 D650 H1300 Seat 430
 inch
 W33.5 D25.5 H51 Seat 17

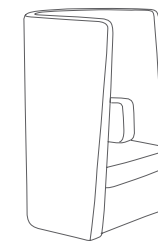

NOBSN12
Busby Chair Right Hand with Cushions
 mm
 W850 D650 H1300 Seat 430
 inch
 W33.5 D25.5 H51 Seat 17

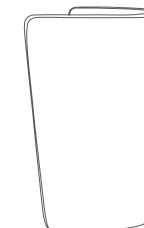
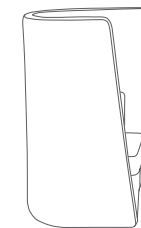

Other Options

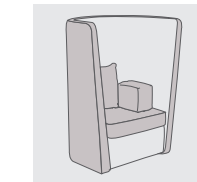

Two Tone
 Outer Seat and Cushions /
 Inner and Front Panel



portion

Chair, Sofa and Bench



About Portion

naughtone's classic sofa system is characterised by the buttoned seat and scooped back. With a unique modular twist on the classic sofa style, Portion is fully customisable, working perfectly in the workplace, hospitality and educational spaces.

Compliance

- SCS Indoor Advantage™ Gold Certificate
- FSC® certified products available upon request
- naughtone is FISP and ISO14001 certified
- Our seating is designed to meet or exceed all EN performance requirements per BS EN 16139:2013

Sizes

All dimensions quoted are rounded to the nearest 5mm or nearest 1/2 inch

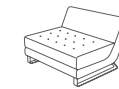

POR1NA
Portion Chair no arms
mm
W900 D870 H610 Seat355
inch
W35.5 D34 H24 Seat14



POR1RA
Portion Chair right arm
mm
W1100 D870 H610 Seat355
inch
W43.5 D34 H24 Seat14



POR1LA
Portion Chair left arm
mm
W1100 D870 H610 Seat355
inch
W43.5 D34 H24 Seat14



POR12A
Portion Chair 2 arms
mm
W1300 D870 H610 Seat355
inch
W51 D34 H24 Seat14

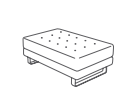

POR1ST
Portion Single Stool
mm
W900 D630 H355 Seat355
inch
W35.5 D25 H14 Seat14



POR2NA
Portion Sofa 2 Seat no arms
mm
W1200 D870 H610 Seat355
inch
W47 D34 H24 Seat14



POR2RA
Portion Sofa 2 Seat right arm
mm
W1400 D870 H610 Seat355
inch
W55 D34 H24 Seat14



POR2LA
Portion Sofa 2 Seat left arm
mm
W1400 D870 H610 Seat355
inch
W55 D34 H24 Seat14



POR22A
Portion Sofa 2 Seat 2 arms
mm
W1600 D870 H610 Seat355
inch
W63 D34 H24 Seat14



POR2BEN
Portion 2 Seat Bench
mm
W1200 D630 H355 Seat355
inch
W47 D25 H14 Seat14



POR3NA
Portion Sofa 3 Seat no arms
mm
W1800 D870 H610 Seat355
inch
W71 D34 H24 Seat14

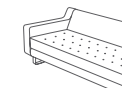

POR3RA
Portion Sofa 3 Seat right arm
mm
W2000 D870 H610 Seat355
inch
W78.5 D34 H24 Seat14

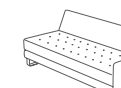

POR3LA
Portion Sofa 3 Seat left arm
mm
W2000 D870 H610 Seat355
inch
W78.5 D34 H24 Seat14



POR32A
Portion Sofa 3 Seat 2 arms
mm
W2200 D870 H610 Seat355
inch
W86.5 D34 H24 Seat14

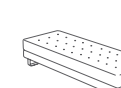

POR3BEN
Portion 3 Seat Bench
mm
W1800 D630 H355 Seat355
inch
W71 D25 H14 Seat14



PORCHR
Portion Chaise right arm
mm
W950 D1345 H610 Seat355
inch
W37.5 D53 H24 Seat14

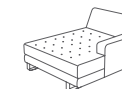

PORCHL
Portion Chaise left arm
mm
W950 D1345 H610 Seat355
inch
W37.5 D53 H24 Seat14

Base Options



Brushed Stainless Steel Base Standard



Turned Solid Oak or Walnut Legs

Other Options



Contrast Button Colours

hatch

Modular Seating



About Hatch







Hatch is designed to be effortless to plan into configurations with its straightforward yet characteristic quilted seat modules. The tactile structure to the fabric provides a satisfying repeat pattern that works across any composition. Hatch has a firm, upright sit and compact dimensions, making it the ideal choice for modern commercial environments such as shops, restaurants or reception lounges.

Compliance

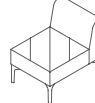
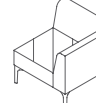
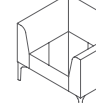
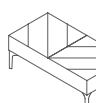
- SCS Indoor Advantage™ Gold Certificate
- FSC® certified products available upon request
- naughtone is FISP and ISO14001 certified
- Our seating is designed to meet or exceed all EN performance requirements per BS EN 16139:2013

Sizes

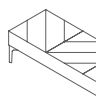
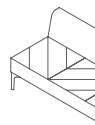
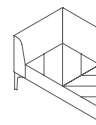
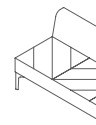
All dimensions quoted are rounded to the nearest 5mm or nearest 1/2 inch

 <p>HAT1ST Hatch Single Stool mm W 510 D 510 H 410 Seat 410 inch W 20 D 20 H 16 Seat 16</p>	 <p>HAT1NA Hatch Chair no arms mm W 510 D 690 H 685 Seat 410 inch W 20 D 27 H 27 Seat 16</p>	 <p>HAT11A Hatch Corner Chair 1 arm mm W 690 D 690 H 685 Seat 410 inch W 27 D 27 H 27 Seat 16</p>	 <p>HAT12A Hatch Chair 2 arms mm W 870 D 690 H 685 Seat 410 inch W 34.5 D 27 H 27 Seat 16</p>	
 <p>HAT2BEN Hatch 2 Seat Bench mm W 1020 D 510 H 410 Seat 410 inch W 40 D 20 H 16 Seat 16</p>	 <p>HAT2NA Hatch 2 Seater no arms mm W 1020 D 690 H 685 Seat 410 inch W 40 D 27 H 27 Seat 16</p>	 <p>HAT2RA Hatch 2 Seater right arm mm W 1200 D 690 H 685 Seat 410 inch W 47 D 27 H 27 Seat 16</p>	 <p>HAT2LA Hatch 2 Seater left arm mm W 1200 D 690 H 685 Seat 410 inch W 47 D 27 H 27 Seat 16</p>	 <p>HAT22A Hatch 2 Seater 2 arms mm W 1380 D 690 H 685 Seat 410 inch W 54.5 D 27 H 27 Seat 16</p>
 <p>HAT3BEN Hatch 3 Seat Bench mm W 1530 D 510 H 410 Seat 410 inch W 60 D 20 H 16 Seat 16</p>	 <p>HAT3NA Hatch 3 Seater no arms mm W 1530 D 690 H 685 Seat 410 inch W 60 D 27 H 27 Seat 16</p>	 <p>HAT3RA Hatch 3 Seater right arm mm W 1710 D 690 H 685 Seat 410 inch W 67.5 D 27 H 27 Seat 16</p>	 <p>HAT3LA Hatch 3 Seater left arm mm W 1710 D 690 H 685 Seat 410 inch W 67.5 D 27 H 27 Seat 16</p>	 <p>HAT32A Hatch 3 Seater 2 arms mm W 1890 D 690 H 685 Seat 410 inch W 74.5 D 27 H 27 Seat 16</p>

Base Options

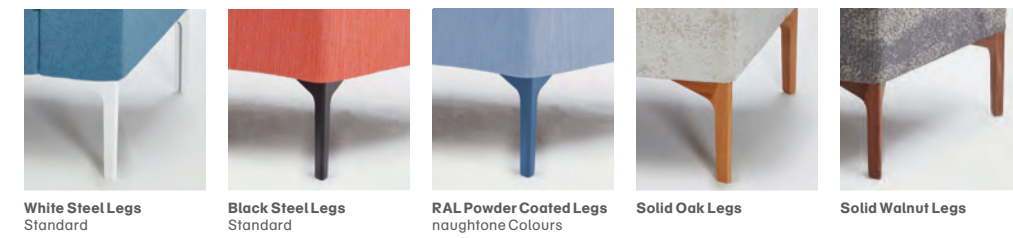

Other Options



symbol

Modular Seating

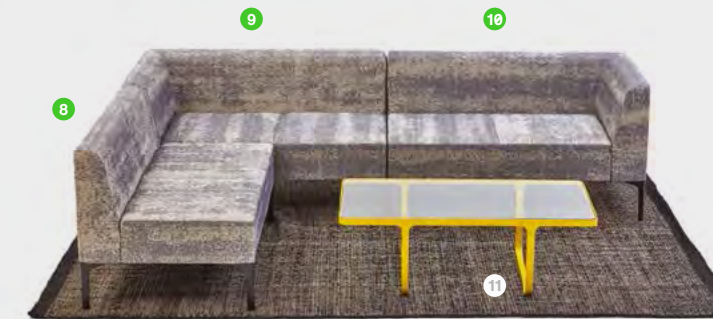
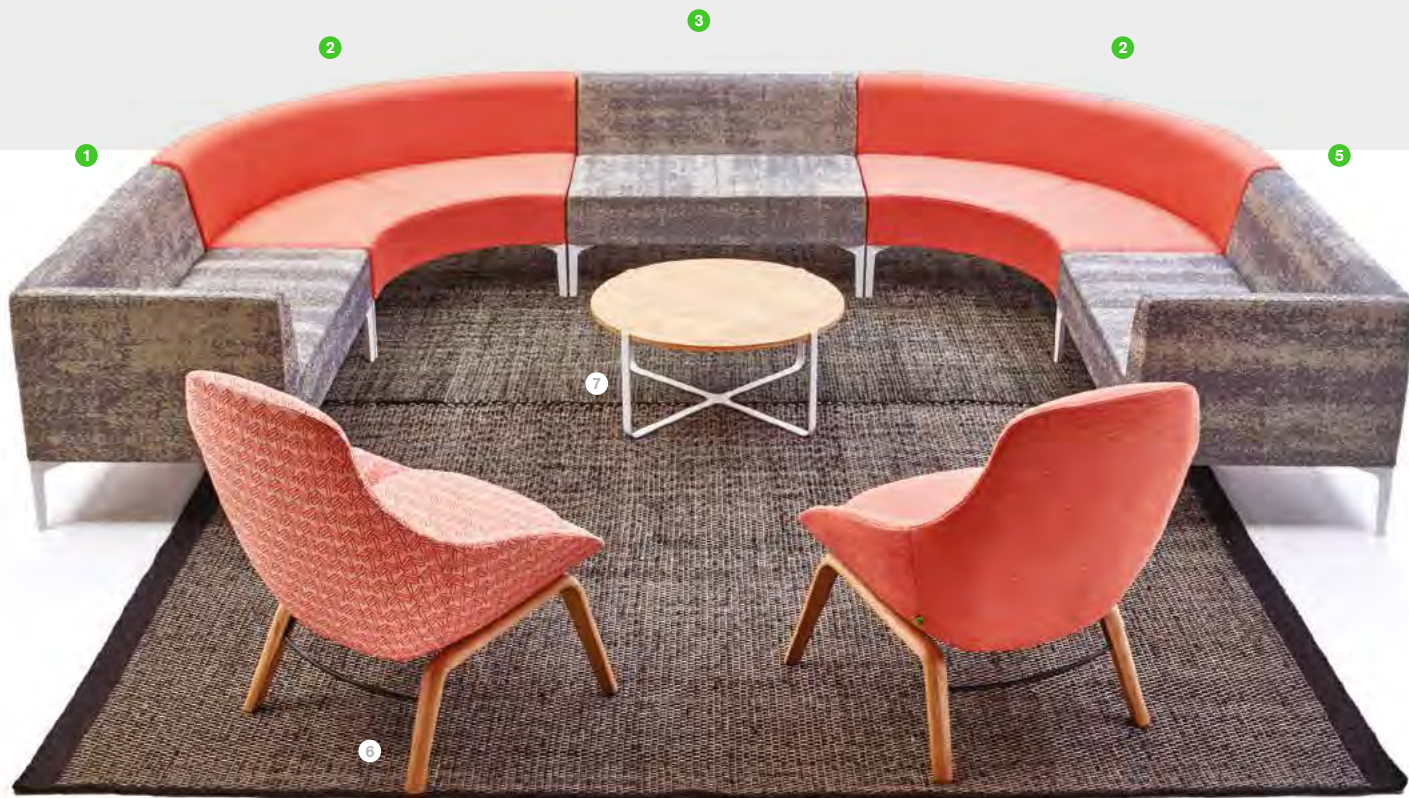

About Symbol

The Symbol seating range has a pared down aesthetic, designed to feel like part of the architecture and provide building blocks for furniture landscapes. Symbol has a firm upright sit and compact dimensions, making it perfect for modern commercial environments where space is at a premium.

Compliance

- SCS Indoor Advantage™ Gold Certificate
- FSC® certified products available upon request
- naughtone is FISP and ISO14001 certified
- Our seating is designed to meet or exceed all EN performance requirements per BS EN 16139:2013

Sizes

All dimensions quoted are rounded to the nearest 5mm or nearest 1/2 inch



SYM1ST
 Symbol Single Stool
 mm
 W510 D510 H410 Seat 410
 inch
 W20 D20 H16 Seat 16

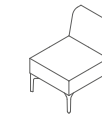

SYM1NA
 Symbol Chair no arms
 mm
 W510 D690 H685 Seat 410
 inch
 W20 D27 H27 Seat 16

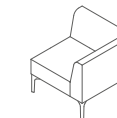

SYM11A
 Symbol Corner Chair 1 arm
 mm
 W690 D690 H685 Seat 410
 inch
 W27 D27 H27 Seat 16

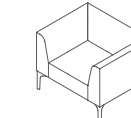

SYM12A
 Symbol Chair 2 arms
 mm
 W870 D690 H685 Seat 410
 inch
 W34.5 D27 H27 Seat 16

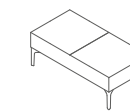

SYM2BEN
 Symbol 2 Seater Bench
 mm
 W1020 D510 H410 Seat 410
 inch
 W40 D20 H16 Seat 16

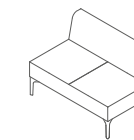

SYM2NA
 Symbol 2 Seater no arms
 mm
 W1020 D690 H685 Seat 410
 inch
 W40 D27 H27 Seat 16

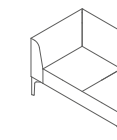

SYM2RA
 Symbol 2 Seater right arm
 mm
 W1200 D690 H685 Seat 410
 inch
 W47 D27 H27 Seat 16

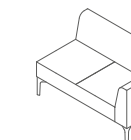

SYM2LA
 Symbol 2 Seater left arm
 mm
 W1200 D690 H685 Seat 410
 inch
 W47 D27 H27 Seat 16

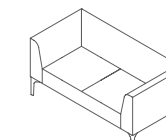

SYM22A
 Symbol 2 Seater 2 arms
 mm
 W1380 D690 H685 Seat 410
 inch
 W54.5 D27 H27 Seat 16

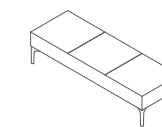

SYM3BEN
 Symbol 3 Seater Bench
 mm
 W1530 D510 H410 Seat 410
 inch
 W60 D20 H16 Seat 16

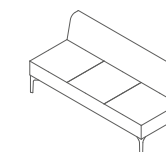

SYM3NA
 Symbol 3 Seater no arms
 mm
 W1530 D690 H685 Seat 410
 inch
 W60 D27 H27 Seat 16

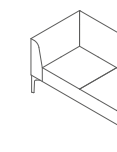

SYM3RA
 Symbol 3 Seater right arm
 mm
 W1710 D690 H685 Seat 410
 inch
 W67.5 D27 H27 Seat 16

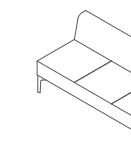

SYM3LA
 Symbol 3 Seater left arm
 mm
 W1710 D690 H685 Seat 410
 inch
 W67.5 D27 H27 Seat 16

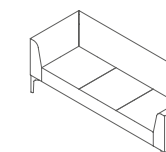

SYM32A
 Symbol 3 Seater 2 arms
 mm
 W1890 D690 H685 Seat 410
 inch
 W74.5 D27 H27 Seat 16

Base Options

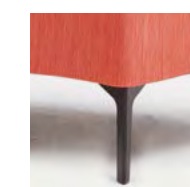

White / Black Steel Legs
 Standard



RAL Powder Coated Legs
 naughtone Colours

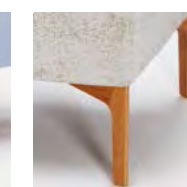

Solid Oak / Walnut Legs

Other Options

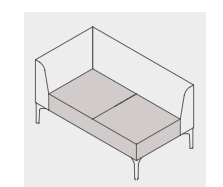

Two Tone
 Backrest and Arms / Seat

symbol

Modular Seating



About Symbol

The Symbol seating and table range has a pared-down aesthetic, designed to feel like part of the architecture and provide building blocks for furniture landscapes.

Symbol has a firm upright sit and compact dimensions and with the addition of the upholstered table, is perfect for modern commercial environments where space is a premium and the furniture must look after itself.

Available with a wide range of leg options as standard and naughtone's wide fabric selection, Symbol is the perfect base for a commercial furniture plan.

Compliance

- SCS Indoor Advantage™ Gold Certificate
- FSC® certified products available upon request
- naughtone is FISP and ISO14001 certified
- Our seating is designed to meet or exceed all EN performance requirements per BS EN 16139:2013

Sizes

All dimensions quoted are rounded to the nearest 5mm or nearest 1/2 inch

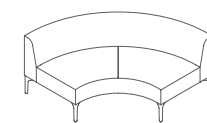

SYM90D
Symbol 90° Curve Sofa
 mm
 W 1825 D 865 H 685 Seat 410
 inch
 W 72 D 34 H 27 Seat 16

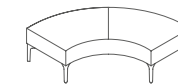

SYM90BEN
Symbol 90° Curve Bench
 mm
 W 1570 D 685 H 410 Seat 410
 inch
 W 62 D 27 H 16 Seat 16

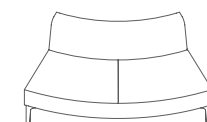

SYM45BEN
Symbol External 45° Curve Sofa
 mm
 W 1200 D 690 H 685 Seat 410
 inch
 W 47 D 27 H 27 Seat 16



SYM45D
Symbol 45° Curve Seat
 mm
 W 1020 D 690 H 685 Seat 410
 inch
 W 40 D 27 H 27 Seat 16



SYMQBEN
Symbol Quarter Circle Bench
 mm
 W 690 D 690 H 410 Seat 410
 inch
 W 27 D 27 H 16 Seat 16

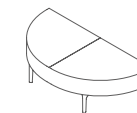

SYM180BEN
Symbol 180° Bench
 mm
 W 1380 D 410 H 410
 inch
 W 54.5 D 16 H 16



SYM45D
Symbol 45° Curve Bench
 mm
 W 1020 D 510 H 410 Seat 410
 inch
 W 40 D 20 H 16 Seat 16

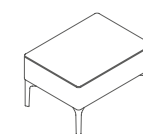

HATSYMTREC
Hatch / Symbol Rectangular Table
 mm
 W 690 D 510 H 410
 inch
 W 27 D 20 H 16

Table Top Options



White / Black MFMD
 with polished MDF edge



Oak Veneer
 with polished MDF edge



Walnut Veneer
 with polished MDF edge

Base Options

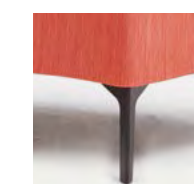

White / Black Steel Legs
 Standard



RAL Powder Coated Legs
 naughtone Colours



Solid Oak / Walnut Legs

Other Options

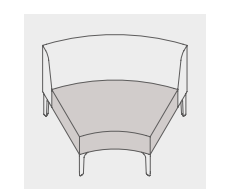

Two Tone
 Backrest and Arms / Seat



clyde club

Chair, Sofa and Bench

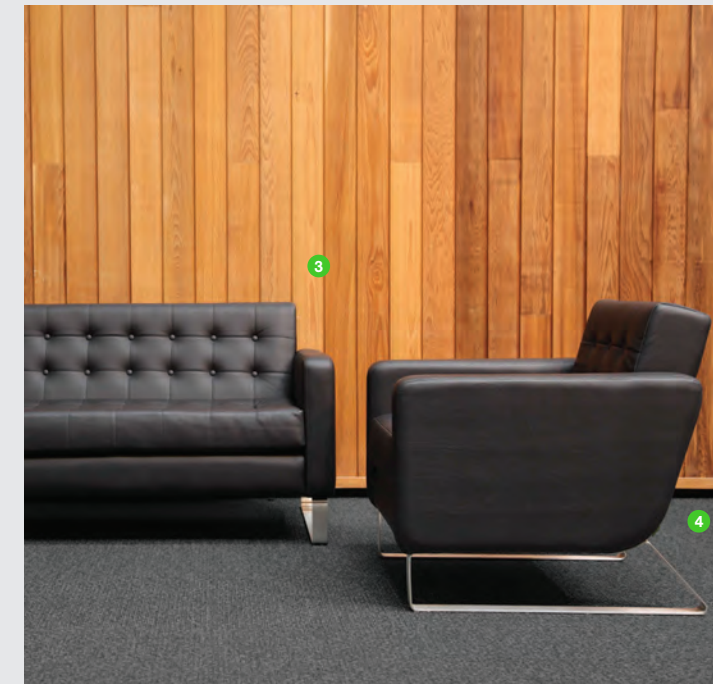

About Clyde Club

Designed with classic functions in mind, The Clyde Club oozes familiarity whilst the scooped profile and stainless-steel sled base retain its unique contemporary edge. Clyde has a comfortable but formal sit, ideal for hospitality and retail environments, whilst the compact footprint rounds off its practical benefits.

Compliance

- SCS Indoor Advantage™ Gold Certificate
- FSC® certified products available upon request
- naughtone is FISP and ISO14001 certified
- Our seating is designed to meet or exceed all EN performance requirements per BS EN 16139:2013

Sizes

All dimensions quoted are rounded to the nearest 5mm or nearest 1/2 inch



CLY1NA
Clyde Club Chair
with No Arms
mm
W 520 D 790 H 760 Seat 420
inch
W 20.5 D 31 H 30 Seat 16.5



CLY12A
Clyde Club Chair
with 2 Arms
mm
W 700 D 790 H 760 Seat 420
inch
W 27.5 D 31 H 30 Seat 16.5



CLY1ST
Clyde Club
Single Stool
mm
W 900 D 550 H 420 Seat 420
inch
W 35.4 D 21.5 H 16.5 Seat 16.5



CLY2NA
Clyde Club 2 Seat Sofa
with No Arms
mm
W 1200 D 790 H 760 Seat 420
inch
W 47 D 31 H 30 Seat 16.5



CLY2RA
Clyde Club 2 Seat Sofa
with Right Arm
mm
W 1280 D 790 H 760 Seat 420
inch
W 50.5 D 31 H 30 Seat 16.5



CLY2LA
Clyde Club 2 Seat Sofa
with Left Arm
mm
W 1280 D 790 H 760 Seat 420
inch
W 50.5 D 31 H 30 Seat 16.5



CLY22A
Clyde Club 2 Seat Sofa
with 2 Arms
mm
W 1360 D 790 H 760 Seat 420
inch
W 53.5 D 31 H 30 Seat 16.5

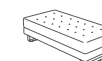

CLY2BEN
Clyde Club
2 Seat Bench
mm
W 1200 D 550 H 420 Seat 420
inch
W 47 D 21.5 H 16.5 Seat 16.5

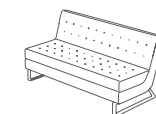

CLY3NA
Clyde Club 3 Seat Sofa
with No Arms
mm
W 1800 D 790 H 760 Seat 420
inch
W 71 D 31 H 30 Seat 16.5

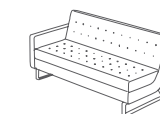

CLY3RA
Clyde Club 3 Seat Sofa
with Right Arm
mm
W 1880 D 790 H 760 Seat 420
inch
W 74 D 31 H 30 Seat 16.5



CLY3LA
Clyde Club 3 Seat Sofa
with Left Arm
mm
W 1880 D 790 H 760 Seat 420
inch
W 74 D 31 H 30 Seat 16.5

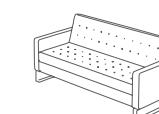

CLY32A
Clyde Club 3 Seat Sofa
with 2 Arms
mm
W 1960 D 790 H 760 Seat 420
inch
W 77 D 31 H 30 Seat 16.5

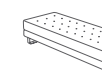

CLY3BEN
Clyde Club
3 Seat Bench
mm
W 1800 D 550 H 420 Seat 420
inch
W 71 D 21.5 H 16.5 Seat 16.5

Base Options



Brushed Stainless
Steel Base
Standard



Turned Solid Oak
or Walnut Legs



Contrast Button Colours